



BREATH-HOLD DIVING 2006

WORKSHOP PROCEEDINGS



Jointly sponsored by the
Undersea and Hyperbaric Medical Society
and Divers Alert Network

BREATH-HOLD DIVING

Workshop Proceedings

June 20-21, 2006

Jointly Sponsored by the

Undersea and Hyperbaric Medical Society

and

Divers Alert Network

Peter Lindholm, MD, PhD

Neal W. Pollock, PhD

Claes EG Lundgren, MD, PhD

Recommended Citation:

Lindholm P, Pollock NW, Lundgren CEG, eds. Breath-hold diving. Proceedings of the Undersea and Hyperbaric Medical Society/Divers Alert Network 2006 June 20-21 Workshop. Durham, NC: Divers Alert Network; 2006.

Copyright © 2006 by
Divers Alert Network
6 West Colony Place
Durham, NC 27705

All rights reserved. No part of this book may be reproduced in any form by photostat, microfilm or any other means without written permission from the publisher.

This diving safety workshop and the publication of this document were jointly sponsored by the Undersea and Hyperbaric Medical Society and Divers Alert Network.

Opinions and data presented at the Workshop and in these Proceedings are those of the contributors, and do not necessarily reflect those of the Undersea and Hyperbaric Medical Society or Divers Alert Network.

Cover design by Alison Ma.

ISBN 978-1-930536-36-4

CONTENTS

UNDERSEA AND HYPERBARIC MEDICAL SOCIETY	v
DIVERS ALERT NETWORK	v
ACKNOWLEDGMENTS	vi
UNIT CONVERSIONS	vi
2006 UHMS/DAN BREATH-HOLD WORKSHOP: OPENING REMARKS	1
THE SCIENCE OF BREATH-HOLD DIVING: PAST, PRESENT AND FUTURE	2
<i>Claes E.G. Lundgren</i>	
NITROGEN NARCOSIS DURING NO LIMITS FREEDIVING	17
WORLD RECORD DIVE TO 160 m (525 ft)	
<i>Tanya Streeter</i>	
PHYSIOLOGICAL MECHANISMS INVOLVED IN THE RISK OF LOSS	26
OF CONSCIOUSNESS DURING BREATH-HOLD DIVING	
<i>Peter Lindholm</i>	
INCREASED LEVELS OF THE BRAIN DAMAGE MARKER S100B AFTER	32
APNEAS IN COMPETITIVE BREATH-HOLD DIVERS	
<i>Johan P.A. Andersson, Mats H. Liner, Henrik Jonsson</i>	
APNEA DIVERS: HYPOXYPHILIACS, ATHLETES, OR VALUABLE	36
MEDICAL RESEARCH SUBJECTS?	
<i>Lynne Ridgway, Ken McFarland</i>	
'SAMBA', 'MOOGLIES' AND OTHER ACUTE EFFECTS OF APNEA	39
<i>Lynne Ridgway, Ken McFarland, Ian B. Stewart, Andrew C. Bulmer</i>	
DEVELOPMENT OF THE DAN BREATH-HOLD INCIDENT DATABASE	46
<i>Neal W. Pollock</i>	
DAN BREATH-HOLD INCIDENT DATABASE: 2004-2005 CASES	56
<i>Sheila J. Modi, Neal W. Pollock</i>	
DIVING HABITS HISTORICALLY ASSOCIATED WITH 'SHALLOW WATER	60
BLACKOUT' IN HAWAIIAN FREEDIVERS	
<i>Richard W. Smerz, Frank Farm, Jr</i>	
A PROPOSED 60 SECOND LIMIT FOR BREATH-HOLD DIVING	64
<i>Frank K. Butler</i>	
SHALLOW WATER BLACKOUT: THE PROBLEM AND A POTENTIAL SOLUTION	75
<i>Terry L. Maas</i>	

SAFETY TECHNIQUES AND PROBLEM MANAGEMENT IN RECREATIONAL AND COMPETITIVE FREEDIVING	82
<i>Kirk Krack, Martin Stepanek, Mandy-Rae Cruickshank</i>	
GLOSSOPHARYNGEAL BREATHING AND BREATH-HOLD DIVING ON EMPTY LUNGS	96
<i>Peter Lindholm</i>	
LARYNGOSPASM IN BREATH-HOLD DIVING	102
<i>Christopher W. Dueker</i>	
CARDIOVASCULAR AND HEMATOLOGICAL ADJUSTMENTS TO APNEIC DIVING IN HUMANS	108
<i>Erika Schagatay, Matt Richardson, Robert deBruijn, Johan P.A. Andersson</i>	
CORRELATION BETWEEN SPLEEN SIZE AND HEMATOCRIT DURING APNEA IN HUMANS	116
<i>Matt Richardson, Robert de Bruijn, Sofia Petterson, Jenny Reimers, Erika Schagatay</i>	
DECOMPRESSION SICKNESS IN BREATH-HOLD DIVING	119
<i>Robert M. Wong</i>	
MANIFESTATION OF DECOMPRESSION ILLNESS IN JAPANESE AMA DIVERS	130
<i>Kiyotaka Kohshi, Yoshihiro Mano, Robert M. Wong</i>	
BRAIN FUNCTION IMAGING IN ASYMPTOMATIC ELITE BREATH-HOLD DIVERS	135
<i>Ralph T. Potkin, J. Michael Uszler</i>	
USE OF ELECTRONIC DATA LOGGERS WITH BREATH-HOLD DIVING	138
<i>Karl E. Huggins, Martin Stepanek</i>	
PANEL DISCUSSION	142
APPENDICES	
A. List of Acronyms Used	160
B. Workshop Participants	161
C. Workshop Schedule	165

UNDERSEA AND HYPERBARIC MEDICAL SOCIETY

www.uhms.org

The UHMS is an international, nonprofit organization serving over 2,500 members from more than 50 countries. Most UHMS members are diving or hyperbaric scientists and physicians. Associate members are nurses, technicians, respiratory therapists and others who work in the field of diving and hyperbaric medicine.

The Undersea and Hyperbaric Medical Society (UHMS) is the primary source of information for diving and hyperbaric medicine physiology worldwide. It was founded as the Undersea Medical Society in 1967 but in 1986 changed the name to Undersea and Hyperbaric Medical Society. The name change reflects the rapidly growing interest in hyperbaric oxygen physiology and therapy. The UHMS's purpose is to provide scientific information to protect the health of sport, military and commercial divers and to improve the scientific basis of hyperbaric oxygen therapy, promote sound treatment protocols and standards of practice and provide CME accreditation.

DIVERS ALERT NETWORK

www.diversalertnetwork.org

Divers Alert Network (DAN[®]) is a 501(c)(3) nonprofit dive safety organization associated with Duke University Health Systems in Durham, N.C. Since 1980, DAN has served as a lifeline for the scuba industry by operating the industry's only 24-Hour Diving Emergency Hotline, a lifesaving service for injured scuba divers. Additionally, DAN operates a Dive Safety and Medical Information Line, conducts vital dive-related medical research and develops and provides a number of educational programs for everyone, from beginning divers to medical professionals.

DAN is supported through membership dues and donations. In return, members receive a number of benefits, including access to emergency medical evacuation, travel and personal assistance for both diving and non-diving needs, DAN educational publications, a subscription to *Alert Diver* magazine and access to diving's premier dive accident insurance coverage. DAN currently has well more than 200,000 members worldwide.

The DAN Vision

Striving to make every dive, accident- and injury-free.

The DAN Mission Statement

DAN helps divers in need with medical emergency assistance and promotes diving safety through research, education, products and services.

ACKNOWLEDGMENTS

Thanks are due to UHMS and DAN for co-sponsoring the workshop, NAVSEA and Office of Naval Research for financial support, our home institutions for support of our time and all the workshop participants.

Additional thanks to Cindi Easterling and Lisa Wasdin for skillful logistics management and Alison Ma and Rick Melvin for cover art production.

Peter Lindholm, MD, PhD

Swedish Defence Research Agency, Centre for Environmental Physiology,
Karolinska Institutet, Stockholm, Sweden

Neal W. Pollock, PhD

Center for Hyperbaric Medicine and Environmental Physiology
Duke University Medical Center

Claes E.G. Lundgren, MD, PhD

Center for Research and Education in Special Environments,
State University of New York at Buffalo



UNIT CONVERSIONS

1.0 m = 3.28084 ft
1.0 ft = 0.30480 m

1.0 mm Hg = 0.13332 kPa
1.0 kPa = 7.50064 mm Hg

1.0 kg = 2.204623 lb
1.0 lb = 0.4535924 kg

$^{\circ}\text{C} = (^{\circ}\text{F} - 32) / 1.8$
 $^{\circ}\text{F} = ^{\circ}\text{C} * 1.8 + 32$

2006 UHMS/DAN BREATH-HOLD WORKSHOP: OPENING REMARKS

DR. LUNDGREN: I am very pleased to get this meeting started. It is 20 years since we had an international symposium or workshop on breath-hold diving on this continent, the last one being in Buffalo. A lot of things have happened in our field over those 20 years, many of which we will take a thorough look at in the next two days.

We want to acknowledge that this event would not have happened without the collaboration between UHMS and DAN. We also wish to recognize the generous support from the Office of Naval Research and Naval Sea Systems Command, for which we are very appreciative.

DR. LINDHOLM: We will start with a few housekeeping details. First, the compact disks provided with the registration packages include the complete proceedings from the 1965 breath-hold diving symposium. We felt this was important to provide since paper copies are becoming increasingly more difficult to find. We thank Eugene Hobbs at Duke University, the same person responsible for scanning the UHMS archives, for providing us with this material.

The second piece of information is that we have a court stenographer with us to produce a verbatim record of the meeting. An edited version of the discussions will be included in the proceedings of the meeting.

Finally, personal issues have demanded the withdrawal of several presenters. This list includes Dr. Andreas Fahlman, Dr. Massimo Ferrigno and Mr. Glennon Gingo.

Welcome.

THE SCIENCE OF BREATH-HOLD DIVING: PAST, PRESENT AND FUTURE

Claes E.G. Lundgren, MD, PhD

Center for Research and Education in Special Environments,
State University of New York at Buffalo, NY, USA

The title of my talk may be too ambitious, especially when it comes to the future, because, after all, as the Danish humorist Storm Pedersen said many years ago, "Predictions are hard to make, especially about the future."

I think what lies in the future in terms of research on breath-hold diving physiology will come out of our discussions here, so it all rests with you. As for the past, I will dwell a bit on what conventional wisdom has said about safety and possibilities when it comes to breath-hold diving, and we will see how reality has come about to set those predictions or those ideas straight. As for the current, it will be the material that will be presented by all of you here.

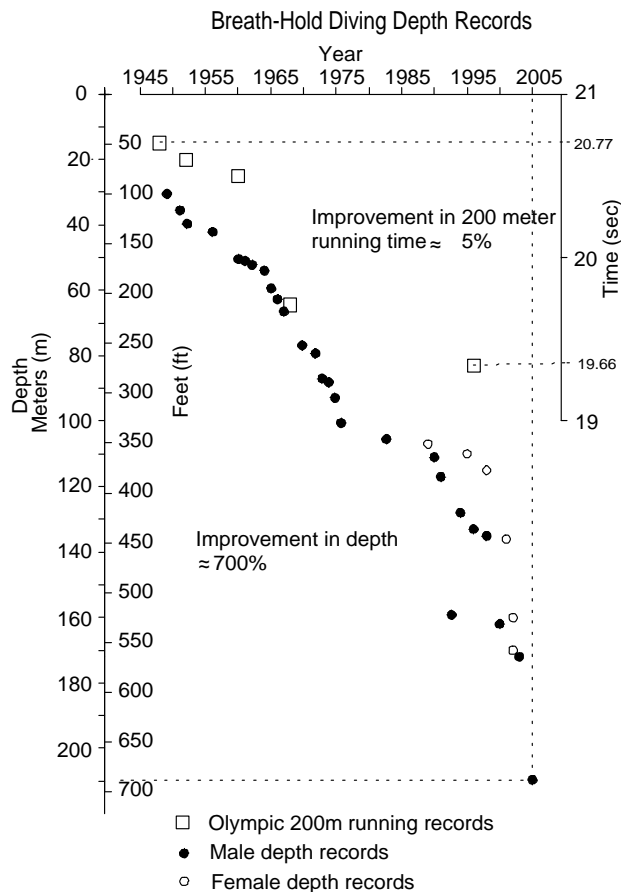

Figure 1: Comparison of improvements in the no-limits breath-hold diving records and Olympic 200 m running records over a 50- to 60-year period (modified from ref. 1).

Now, some of you may have seen one version of this diagram before. This time I have added something that I think is quite astounding. When you reflect on the immense increase in diving depths for maximal breath-hold dives that has progressed from the mid- to late forties, when dives reached down to maybe 30 or 40 m, to the most recent record that I am aware of, which is 209 m (686 ft), it is more than a 700% increase in performance. Now, for comparison, look at the Olympic records. I have chosen, because there was a fair number of data available, the Olympic records for 200 m runs, which has progressed along this line. Now you have, of course, to pay attention to the time scale for the runs, which is in seconds. So we have from 1950, about 20.6 s, to the most recent 1995 record, which is about 19.4 s, a five percent improvement. I do not know that there is any other athletic activity that can show the same improvement in records as deep breath-hold diving. And all the time happening in the face of, we have to admit it, scientists predicting, that the limits would be much, much less than what the divers have shown us.

It does force us to recognize that there is a credibility problem to some extent between us in the labs and the divers who are spearheading the progress in the field. And it is an unfortunate problem, because we do feel that communication is extremely important.

For those who are on the diving side more than on the laboratory side, I would like to emphasize that the reason that the apparently too restrictive limits were proposed at one time or another was that they were based on insights and knowledge that had been gained, not by studying divers, but by studying lung physiology in healthy, non-diving people and patients. And the other reason, of course, was that since much of this was driven by physicians, there would be an overriding concern of not encouraging activities that might do harm.

On the other hand, as I will elaborate a bit on, there are some observations and predictions that I think the divers should take into consideration when it comes to potentially noxious effects of extreme diving. And we will hear a fair amount about that as we go on.

One of the first concerns was the possibility that the pressure and chest and lung compression would do harm. Consider a dive to 200 m (656 ft). And just for those of you who may not have pondered the finer points of this before, let us look at somebody going from the surface starting out with, let us say, a total lung volume of 9 L down to this record depth of currently 200 m. At 200 m the gas in the lungs has been compressed to less than 0.5 L (that is more than one liter less than the normal residual volume). For simplicity we can disregard small effects of oxygen and CO₂ exchange. Going from 9.0 L to 0.4 L is a tremendous compression. And the question that for the longest time concerned researchers was, of course, while air certainly is compressed in the lungs and therefore the lungs should be compressed, what about the chest wall and the discrepancy in compressibility between the chest wall and the lungs? The chest wall in humans is certainly not as compressible as it is in, for instance, the diving mammals where the chest wall is less developed, less stiff.

So, going down, let us look at the predictions as they used to be. The following numbers are for measurements we did in an expert breath-hold diver diving in the wet-pot of our hyperbaric chamber. His vital capacity was 7.4 L, his residual volume was 2.2 L, for a total lung capacity of 9.6 L. If one predicts, as the rule was not too many years ago, the maximally safe diving depth based on the ratio between the total lung capacity to residual volume (this assumes, of course, that the diver inhaled maximally before diving) then $9.6/2.2 \sim 4.4$, that is a compression to 4.4 ATA. Thus, the prediction from this data would be for his safe maximum depth to be 34 m (112 ft). Well, when we put this data together, he had done a dive to 133 m (436 ft), which makes for a compression of the lung air down to 0.67 L. Yet, his residual volume measured at the surface was 2.2 L. So there is a discrepancy of $2.2 - 0.67 = \sim 1.5$ L that has to be explained. And the explanation is, to a large extent, that blood fills the void, so to speak, between the chest wall and the lung.

As a matter of fact, we have recordings by pneumography taking external measures of the chest volume in another well-known breath-hold diver, Enzo Majorca – and when I mention names in this presentation, it is with the consent of the person in question – Enzo did dives in our wet pot, one dive to 55 m (180 ft) and another to 50 m (164 ft) while we measured the chest volume (Figure 2).

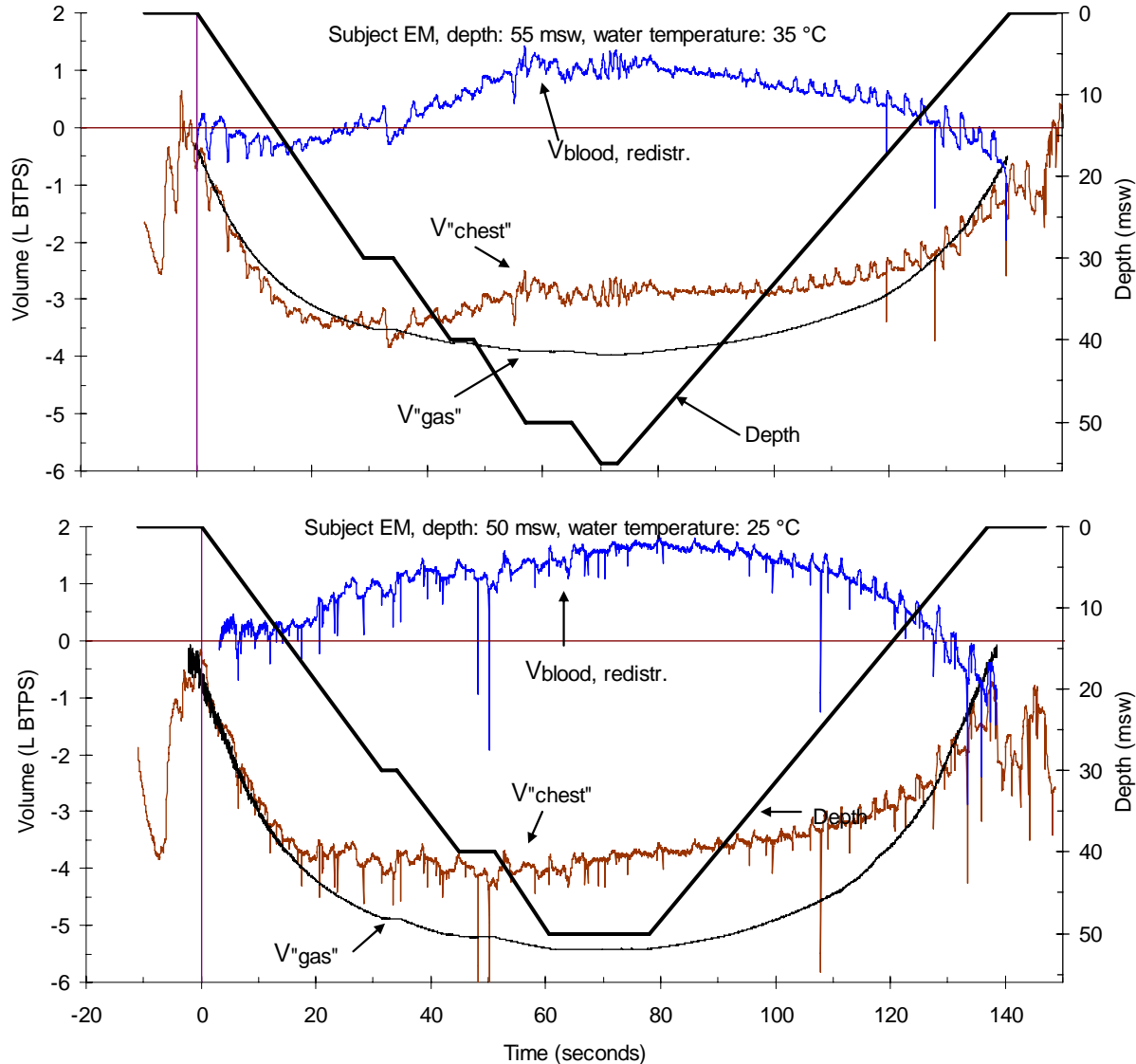

Figure 2: Submersed breath-hold dives to 55 m (180 ft) in water at 35°C (95°F) and to 50 m (164 ft) at 25°C (77°F) in hyperbaric chamber performed by Enzo Majorca. Difference between calculated compression of lung gas and measured reduction in chest volume shown as volume of blood (area above zero volume line) redistributed from periphery into chest (Figure courtesy Drs. D. Warkander, M. Ferrigno, C. Lundgren).

Furthermore, since we knew the volume of air he had in his lungs when he started the dive we could calculate the compression of that air as he descended to gradually greater pressure. The idea was to compare the volume of that air with the chest volume. Both of these graphs are designed the same way. This is the time/depth profile down to and up from 55 m (180 ft). You have the smooth line

showing what is predicted in terms of compression of the air in the lung as he goes down. It is maximally compressed at the 'bottom.' And then as he goes up, it expands again. Contrast that with the actually measured reduction in chest volume and you can see that there is a considerable discrepancy between the chest volume line and the lung-gas volume line.

We have set off this difference up here as a volume of blood redistributed. In this particular dive, it is in the order of one liter of blood entering the chest, entering the space, so to speak, between the chest and the lung. In reality, of course, it is distending the volume of the blood vessels in the chest. This was Enzo's second dive, down to 50 m (164 ft). It produced a redistribution of about 1.5 L of blood to his chest.

Now, what explains the larger volume of blood shift that is, one and a half liter at the lesser pressure at 50 m (164 ft) than the one liter shift at 55 m (180 ft)? That is probably answered by the difference in water temperatures, 25°C (77°F) at 50 m water versus 35°C (95°F) at 55 m (180 ft). The effect of the colder water was, in all likelihood, to cause constriction of peripheral blood vessels so as to shift more blood from the periphery into the chest than in the relatively warm water.

Thus, there is, without doubt, a very considerable distension of the blood vessels in the chest during breath-hold diving. The question then worrying the researchers is: can that be safe? Is really the human pulmonary vasculature designed to accept such tremendous volumes of blood? It is clearly very unnatural, compared to the situation of normal life on dry land.

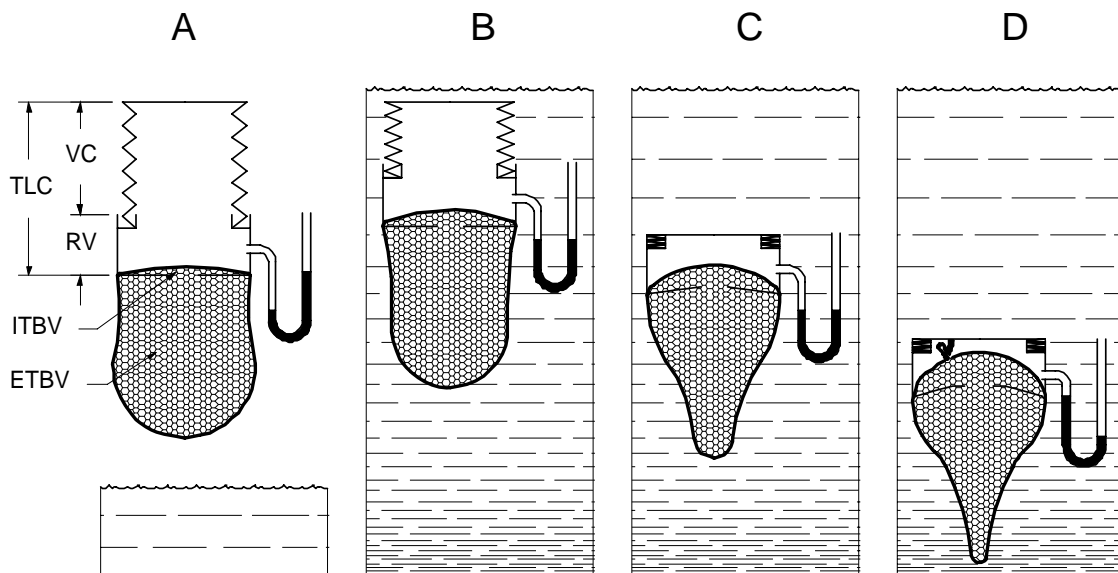

Figure 3: Schematic of the lungs and the distribution of blood that can be moved from the periphery into the blood vessels of the chest. A hypothetical u-tube manometer compares the gas pressure in the lung with the water pressure surrounding the chest (chest wall not shown). TLC is total lung capacity and VC, i.e., the vital capacity represents the compressible part of the chest and lungs; residual volume (RV) is the incompressible part; ITBV is intrathoracic blood volume and ETBV is extrathoracic blood volume. A: the situation after inhalation to TLC before dive with small ITBV and because of recoil of chest and lungs a positive pressure in lung; B: beginning of dive with partial compression of chest and some increase in ITBV, pressure equilibrated between lung air and water; C: At this depth the chest-wall-lung system has reached RV and cannot be

compressed more from the outside so additional blood is moved ('sucked in') from the ETBV to the ITBV and pressure equilibrium is maintained; D: with increasing depth lung gas pressure is lagging behind water pressure drawing in more blood because of limited distensibility and full pressure equilibrium is not reached, i.e., blood pressure in the vessels is higher than air pressure on the outside of the vessels which may burst (Figure reproduced from ref. 1 with permission).

This is fine for theory but is over-distension of blood vessels in the lung and bleeding something really to be concerned about? One of the first positive demonstrations of intrapulmonary hemorrhage was presented by Boussuges and co-workers in France when a diver had done repetitive dives to about 20 m (66 ft) during the day, started coughing up blood. He had a chest x-ray taken and pulmonary lavage was also performed and confirmed that he had blood in the alveoli. So it is definitively a potential risk. The remarkable thing is that there are people who can go down to considerable depth apparently without any problems. And we have accounts of divers who bleed at 20 m or 30 m (66 or 98 ft). It is still a medical mystery why there is this difference because some of those individuals have been subject to extensive diagnostic procedures without the bleeding source being found.

There is one medical condition that has been suggested as a possible explanation in these cases of bleeding after diving, and that is called the Osler disease, which is a condition with blood vessel malformations that can be located in many different areas of the body, from the skin to the gastrointestinal tract, and certainly in the lungs. These are somewhat akin to varicose veins. They are actually located in the transition from arteries to veins, and may be weak points in, in this case, the pulmonary blood circulation that could perhaps more easily rupture than the rest of the vascular bed.

There is other pathology which we will hear more about. Not too long ago it was claimed that there are some natural divers who dive very, very safely, although very intensively, and those are in particular, the Korean and Japanese Ama, who, it was at one time said, almost never suffered any ill consequences from the diving. As we will hear later, the reality is sometimes quite different. Japanese breath-hold divers have been diagnosed with severe brain lesions, most likely caused by decompression trauma (2)

As it comes to oxygen usage and the risk of hypoxia during breath-hold diving, predictions again based on conventional physiological wisdom fall considerably short of what reality and current breath-hold divers are teaching us. Without going into all the fine details, let me just say that if you assume a normal total lung capacity, say, of 6.5 L, and look at how much oxygen is available for metabolism without risking severe oxygen lack, and if you hyperventilate before the dive, you may have something in the order of 14 percent of that gas volume available as oxygen. That comes out to about 900 mL of oxygen in your lungs available for metabolism before you get down to an oxygen pressure of 30 mm Hg – this is at the surface now – at which point you should lose consciousness.

Those 900 mL would last, assuming a standard resting oxygen consumption of $300 \text{ mL}\cdot\text{min}^{-1}$, for three minutes. Then, the doctor says, you are going to lose consciousness from hypoxia. Yet, the current static apnea record, held by Tom Sietta, is not three minutes but an astounding 8:58 min:s. So, explanations? Well, one thing that breath-hold divers do that does help a bit in terms of increasing the lung oxygen store is glossopharyngeal breathing. However, that can only increase breath-holding time another half minute or so.

Then there is the improved storage capacity of the blood for oxygen after a series of dives because of an infusion into the circulation of erythrocytes from the spleen (3) with some potential to store extra

oxygen, although I believe it is a rather modest effect. There is also the question whether the oxygen usage of the diver is not $300 \text{ mL}\cdot\text{min}^{-1}$ but perhaps something less, in which case, of course, the stores would last longer. Now, this brings us to the well-known phenomenon of the diving response. Here illustrated by recordings in Rossana Majorca in dives in our chamber to 50 m underwater. She had graciously accepted to have an arterial catheter put into an artery in her arm for continuous blood pressure recording and we also recorded her electrocardiogram (Figure 4).

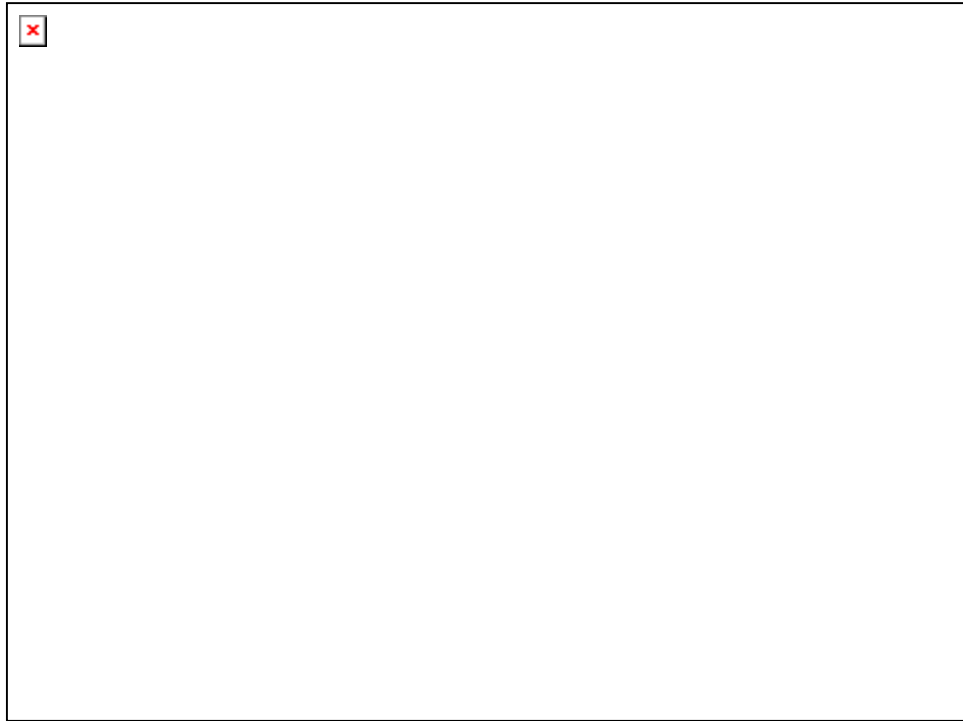

Figure 4: Rossana Majorca's submersed dive in water at 25°C to 50 m (164 ft) in hyperbaric chamber. Recordings (against time) from top to bottom: electrocardiogram (ECG), invasively measured arterial blood pressure, depth profile and breath-hold dive duration. For comments see text. (Figure used with permission from ref. 4).

What is striking here, first of course, is that this was a somewhat stressful or at least exciting moment where she was compressed underwater in the chamber at a relatively rapid rate. There was some tachycardia and a slightly raised blood pressure of 180/110 mm Hg or so in the beginning. When the dive starts, however, something quite remarkable happens. In this young, healthy woman with otherwise normal resting blood pressure but who is now in a diving situation, the blood pressure shoots up to this amazing level, the diastolic blood pressure at 190 mm Hg, and the systolic pressure can be extrapolated to be about 280 mm Hg. Absolutely amazing. Then comes the diving bradycardia and the pressure comes down. This is physiologically very interesting because it is being debated and I do not claim that a couple of recordings that we have done in Rossana and her farther, showing exactly the same thing, are conclusive proof that this is the primary mechanism in the diving response. But it suggests that the rise in blood pressure is an important factor that causes the slowing of the heart. It would do so by triggering the pressor reflex from the pressor receptors in the arteries and causing reduction in sympathetic tone and lowering of peripheral resistance and, as you can see, slowing the heart rate and therefore causing a drop in the cardiac output which would lead to the reduction in blood pressure. Then, at the end of the ascent, you see the circulation picking up and pressure getting back to where it was at the start.

Now, here are parts of ECG recordings in Enzo, Patricia and Rossana Majorca performing submersed dives in our chamber (Figure 5). The dives caused marked slowing of the heart and ventricular extrasystoles and we recorded heart rates of 8-10 beats·min⁻¹ which looked very dramatic but only lasted for a very short time: tenths of seconds.

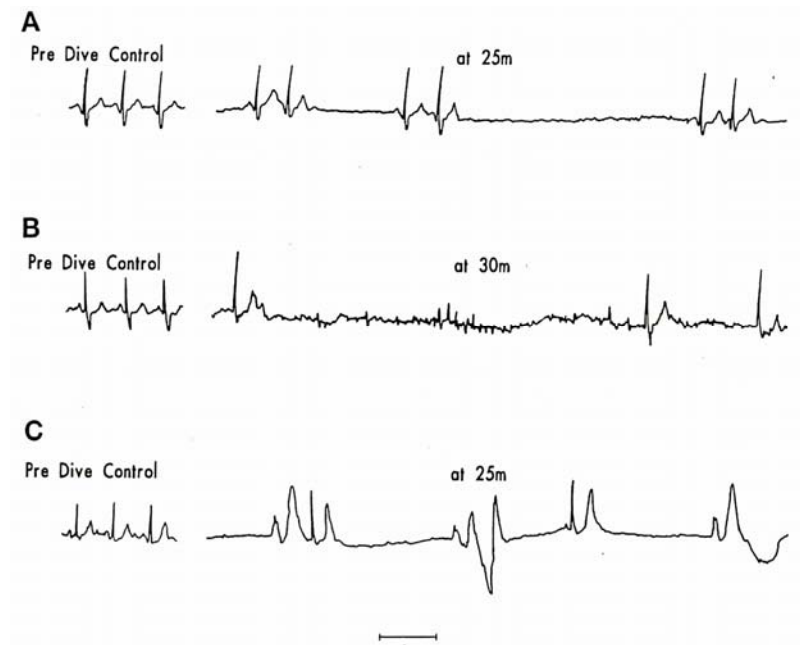

Figure 5. ECG recordings during submersed descending dives in hyperbaric chamber in EM (A) to 50 m, PM (B) to 40 m and RM (C) to 50 m; top tracing recorded before dive and lower tracing at depth indicated (Figure used with permission from ref. 5).

This irregularity in heartbeat has also been observed by others and is apparently not of great concern in an absolutely healthy person but it may be a different thing in somebody with a heart condition – more about that in a while. But first something about the significance of the diving bradycardia, that is, the slowing of the heart.

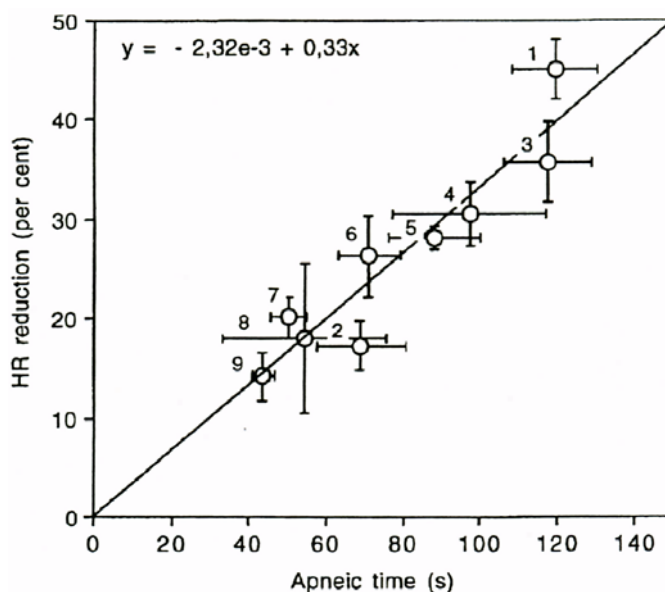

Figure 6: Diving response in terms of heart rate reduction (HR) vs. duration of maximal effort breath-holds during face immersion in cool water. Groups 1 to 3 were experienced breath-hold divers, Group 4 was scuba divers and Groups 5 to 9 were non-divers. Diving bradycardia was more pronounced and breath-holding time was longer in divers, but less so in older individuals (Group 2, Ama) (Figure used with permission from ref. 6).

It shows very nicely that the more pronounced the diving bradycardia is in divers the longer they can hold their breath. In other words, it suggests that the diving response is beneficial for diving performance.

I wish I could put in here another group, which would, however, be very hard to do the proper experiments in, and that is little children, babies or toddlers who have been trained to swim underwater, which they gladly do, if trained correctly. They have quite a vigorous diving response, although, of course, you can never test to see what their maximum breath-holding duration is. What makes this so fascinating is that nature apparently has given kids – this ability to react in a very appropriate fashion to a situation of threatening suffocation. Why so? Well, in the process of being born you are indeed, for a relative brief period of time, subjected to an enforced hypoxia that can become extremely severe. It starts when the child passes the birth canal and the chest is kept in a very firm grip so that it cannot expand even after the face has broken through, and the umbilical cord is also compressed. The face has broken through and is cooled by the outside air and a profound diving response develops. It can actually last for minutes after full delivery. This is nature's carefully tested and through evolution developed method of protecting against dangerous hypoxia in the process of birth.

The diving response is actually found almost throughout the entire animal kingdom, certainly among vertebrates. It has even been demonstrated in slugs and in fish (Figure 7).

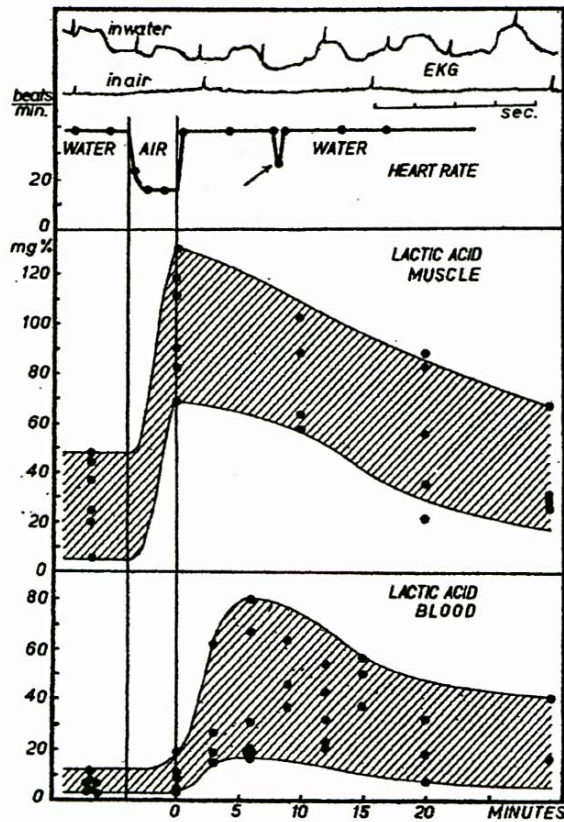

Figure 7: Hypoxic stress generated in cod fish lifted out of its aquarium results in bradycardia and anaerobic metabolism which is remedied when the fish is put back in the water (Reprinted with permission from ref. 7).

Look at the heart rate. What shall we call it, diving bradycardia? A clear, strong bradycardia, normal heartbeat being restored when it is put back into the water. Note also the increases in blood and muscle lactate after the hypoxic episode. It is equivalent to our situation being dipped underwater when the fish is pulled up on the dry. And it might serve survival in this case. So it is a reaction, the diving response, that has been found valuable throughout the animal kingdom for survival.

I talked about the possibility that in us, humans, the rather modest oxygen stores in the lungs, in the blood, and some little in the tissues would last longer because of reduced oxygen usage in divers. Here are some measurements we did, again in the three Majorcas, some years ago. They did breath-holds in a dry environment in the laboratory (Figure 8).

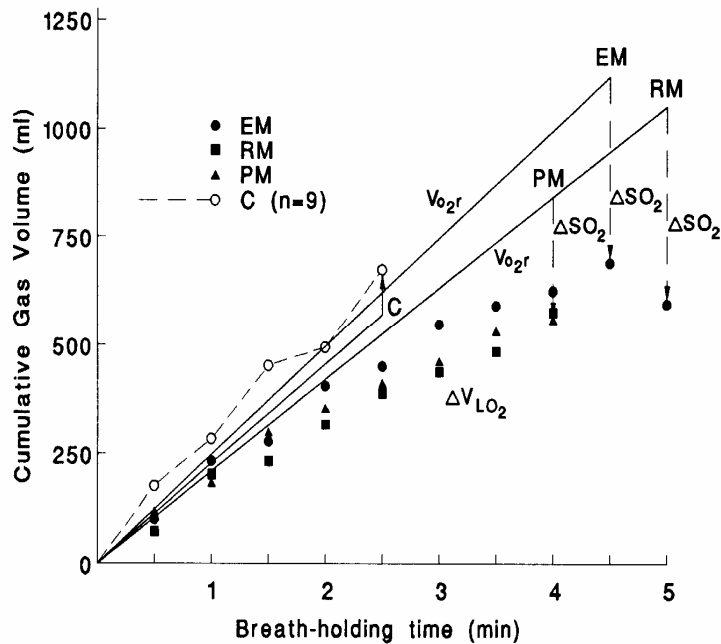

Figure 8: On the horizontal axis is the breath-holding time. They held for something in the order of four to five minutes. The vertical axis shows oxygen uptake. This is based on analysis of the oxygen content in the lung air in repeated breath-holds. So each point here is where the breath-hold on command was broken and a sample of the lung air was taken to analyze how much of the oxygen had disappeared. Clearly, oxygen uptake from the lung is growing as they hold their breath, but at a slower and slower pace, especially when you compare it to the normal resting oxygen consumption, which is represented by these straight lines, you can see that they definitely use less when they hold their breath. The straight lines represent oxygen uptake when breathed quietly, and we just measured oxygen consumption in the normal way. And here (open circles) are age and sex-matched non-diving controls, in whom oxygen consumption, when they hold their breath, just reproduces their normal oxygen consumption when breathing. (Used with permission from ref. 8).

So certainly these divers were a breed apart, but what this figure illustrates applies to breath-hold divers in general. And recordings in several laboratories have now shown that if you look at the oxygen content in blood measured as oxygen saturation during divers' breath-holds it falls at a much slower pace than in non-divers.

Another aspect of adaptation to breath-hold diving that probably is primarily due to training, is shown here again in our favorite subjects, the Majorcas (Figure 9).

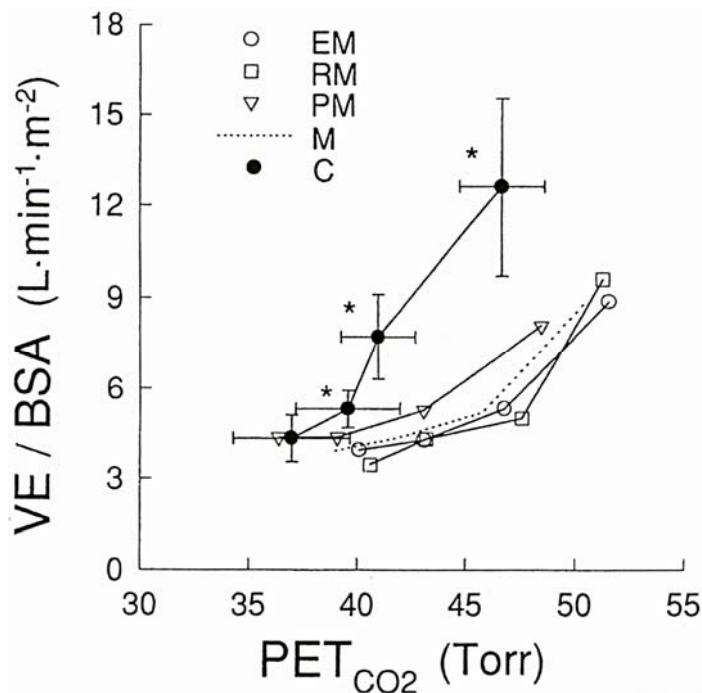

Figure 9: Recording of relationship between spontaneous lung ventilation (vertical axis) and end-tidal CO₂ pressure (horizontal axis) increased by inhalation of stepwise increased CO₂ concentrations in an O₂-CO₂-N₂ mixture. Open symbols: three expert breath-hold divers; filled symbols: age and sex matched non-divers (reprinted from ref. 9 with permission from Elsevier).

Recorded in the laboratory is their breathing in response to step-wise increases in CO₂ in inhaled air. As the resulting CO₂ pressure in their lungs (horizontal axis) and arterial blood increases they react with increased ventilation (vertical axis), according to this pattern. In other words, this is an expression of their ventilatory CO₂ sensitivity; the age-matched, non-diving controls were much more sensitive. You can see much steeper rise in the stimulation from the CO₂ of the breathing in the non-divers. So the breath-hold divers are less sensitive to CO₂ build-up, good and bad. They can hold their breath longer, but also face an increased risk, of course, of running into hypoxia, an aspect that will be dealt with in various presentations to come.

I am getting back to the observation of irregular heart-beat during breath-hold diving, Figure 10. Our divers made two dives each in our dive chamber, one to 50 m (164 ft), one to 40 m (131 ft), and here is another to 50 m. There is an important difference between the two dives that each one did. One dive was in cool water (25°C/77°F) and one in thermoneutral water (35°C/95°F). Note the dive profiles to either 40 or 50 m.

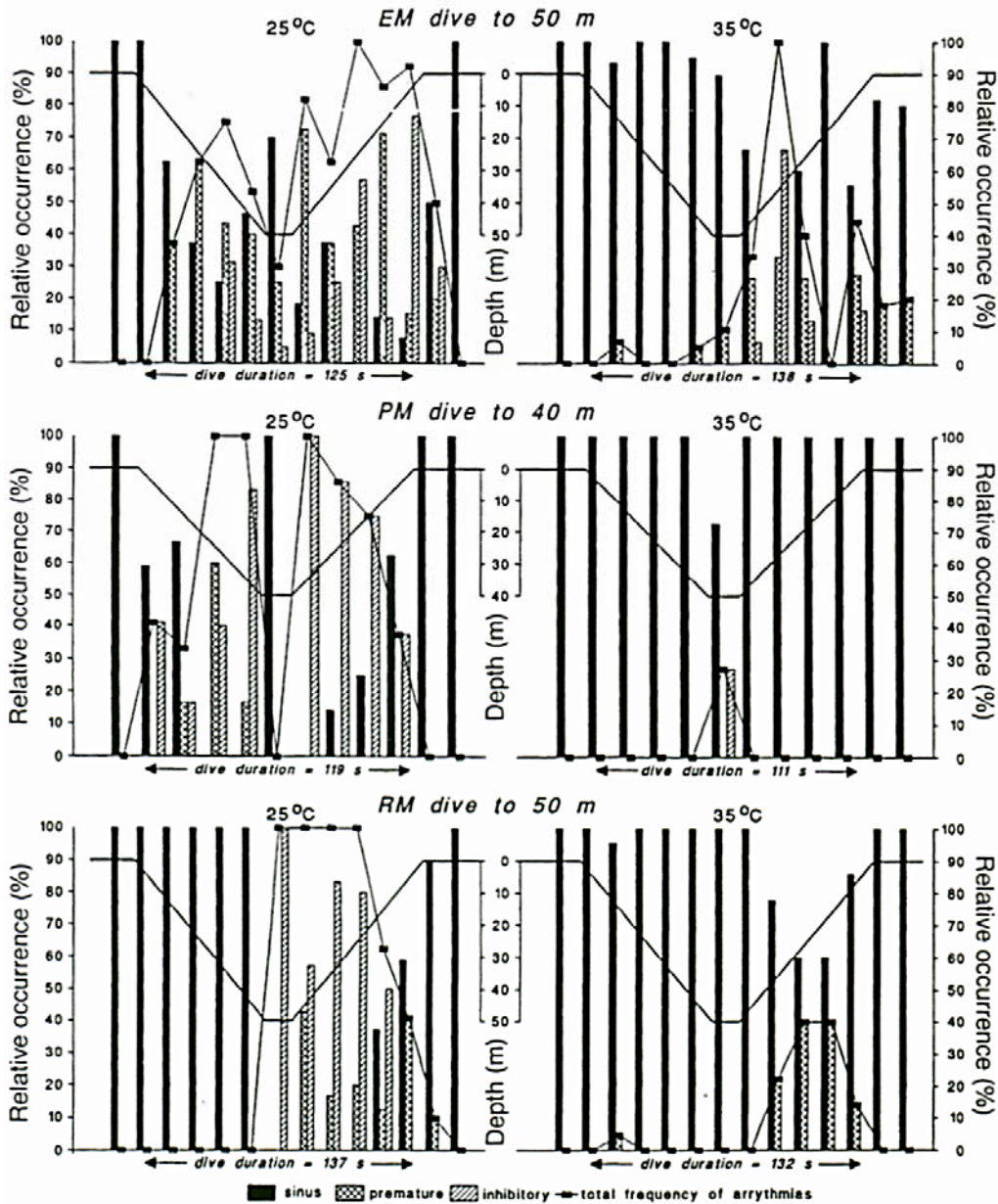

Figure 10. Relative occurrence of arrhythmias at depth vs. time during submersed breath-hold dives, performed by three experienced divers (EM, PM, RM), in a hyperbaric chamber. Measurements were averaged over 10 s intervals. Note the higher incidence of arrhythmias in cool water (25°C/77°F) than in thermoneutral (35°C/95°F) water (Figure used with permission from ref. 4).

And what we have put down here is the frequency of normal (sinus) heartbeats. That is to say, relative occurrence of normal heartbeats and various types of arrhythmias. We have some abnormal beats emerging from not the normal source for heartbeat, namely the sinus node, but from various other locations and with different patterns and we have tied them (black squares) together with the dotted lines in the figure. So the lines delineate the bulk of abnormal heartbeats over the periods of time that

the dives lasted. Note that the areas in the figures representing the amount, so to speak, of abnormal beats are much larger in the dives in cool water than in the dives in thermoneutral water. So what we are looking at here is a heartbeat pattern which is abnormal for healthy individuals during their everyday life but which is brought about as part of the diving response. This has, as I mentioned before been reported by other researchers but the distinction between the effects of cold and warmer water has not been made earlier. So of what consequence is it? Probably none in the healthy individual. But I would like to suggest that, in persons with heart conditions, maybe unknown, this could be the trigger of potentially fatal arrhythmias. And there are certainly cases heard of where somebody does a dive and for no clear reason dies in that dive. On autopsy they may not show any serious cardiovascular disease, but you would not expect that necessarily, if it is a fatal arrhythmia, such as ventricular fibrillation.

Now, much of our discussion about the effects of breath-hold diving in terms of clinical risks is concentrated on the question of hypoxic damage. And we will hear more about that in the coming presentations. I would just like to raise the question here: is there possibly a similar risk for divers subjecting themselves to repeated episodes of rather severe hypoxia especially as it happens in static apnea as there appears to be in persons suffering from sleep apnea. There is a recent study (10) which has shown cognitive deficits in sleep apnea patients. Admittedly, the hypoxic periods in sleep apnea are much more frequent than the hypoxia exposures in breath-hold divers but it is worth noting that many repetitive insults can even if, after each acute episode not much is noticed, accumulate damage.

Ladies and gentlemen: thank you for your attention – the floor is all yours and we are very much looking forward to hear about the science and practice of breath-hold diving , today and in the future.

References

1. Ferrigno M, Lundgren CEG. Human Breath-Hold Diving. In: *The Lung at Depth in the series Lung Biology in Health and Disease*. Lundgren CEG, Miller J, eds. New York: Marcel Dekker (now: Routledge/Taylor & Francis Group LLC), 1999; 132: 529-585.
2. Koshi K., Kinoshita Y., Abe H., et al. Multiple cerebral infarction in Japanese breath-hold divers: two case reports. *Mt Sinai J Med* 1998; 65(4): 280-283.
3. Schagatay E., Andersson JPA., Hallén M., Pålsson B. Selected Contribution: Role of spleen emptying in prolonging apneas in humans. *J Appl Physiol* 2001; 90:1623-1629.
4. Ferrigno M, Ferretti G, Ellis A, Warkander DE, Costa M, Cerretelli P, Lundgren CEG. Cardiovascular changes during deep breath-hold dives in a pressure chamber. *J Appl Physiol* 1997; 83: 1282-1290.
5. Ferrigno M, Grassi B, Ferretti G, Costa M, Marconi C, Cerretelli P, Lundgren CEG. Electrocardiogram during deep breath-hold dives by elite divers. *Undersea Biomed Res* 1991; 18(2): 81-91.
6. Schagatay E, Andersson J. Diving response and apneic time in humans. *Undersea Hyperb Med* 1998; 25(1): 13-19.
7. Leivestad H, Andersen H, Scholander PF. Physiological response to air exposure in codfish. *Science, New Series* 1957; 126(3272): 505.

8. Ferretti G, Costa M, Ferrigno M, Grassi B, Marconi C, Lundgren CED, Cerretelli P. Alveolar gas composition and exchange during deep breath-hold diving and dry breath-holds in elite divers. *J Appl Physiol* 1991; 70(2): 794-802.
9. Grassi B, Ferretti G, Costa M, Ferrigno M, Panzacchi A, Lundgren CEG, Marconi C, Cerretelli P. Ventilatory responses to hypercapnia and hypoxia in elite breath-hold divers. *Resp Physiol* 1994; 97: 323-332.
10. Gale SD, Hopkins RO. Effects of hypoxia on the brain: neuroimaging and neuropsychological findings following carbon monoxide poisoning and obstructive sleep apnea. *J Internat Neuropsychol Soc* 2004; 10(1): 60-71.

WORKSHOP DISCUSSION

UNIDENTIFIED SPEAKER: I was intrigued by the CO₂ response curves. And it seems that everybody is breaking around 55 mm Hg approximately. So there must be some change in the release of CO₂ into the circulation, otherwise it would not be all breaking at the same point.

DR. LUNDGREN: Good point. And to the extent that we accept the idea of reduced metabolism, of course, you could have an extended breath-hold without necessarily breaking at a higher point. But there is, from Carl Schaffer's work many, many years back some studies in which he recorded ventilatory sensitivity to CO₂ and showed that in submarine escape tank instructors it was the same phenomenon. And it was clearly a training-related phenomenon where they lost it when they went on other duties for three or four weeks. And when they came back, they were normal in terms of their CO₂ sensitivity.

UNIDENTIFIED SPEAKER: It must be that there is decreased metabolism but increased CO₂, otherwise, the breaking points would be different.

DR. LUNDGREN: That is correct.

DR. MUTH: We made measures and we could show by arterial drawn blood gases that the CO₂ does not increase because of various reasons. There is, on the one hand, the effect of the diving response, but on the other hand, you have a very strong effect by the old day effect, which says de-oxygenized hemoglobin can take up CO₂. And thus, the CO₂, the PCO₂ does not rise. So, in our measurements you could clearly see that the PO₂ rises with depth, as predicted, and falls down by using of the body, but the CO₂ curve was more or less on the same level.

Another story is that the competitive apnea divers deny doing hyperventilation, but they all do yoga. If you take arterial blood gases just before they go for their dive, you will see PCO₂ levels around 28 to 29 mm Hg. So this contributes to the effect as well.

DR. LUNDGREN: Another aspect of the body's CO₂ handling in diving which we have studied and not been able to fully explain, is the very clear increase in the body's ability to store – other than the blood – to store CO₂, when you are surrounded by water, and probably related to changes in distribution of blood flow just by being submersed. So there are several aspects to this question of how the body handles the CO₂ economy, if you will, in breath-holding and immersion.

DR. RISBERG: That might put an end to the diving reflex, because I think it is a bit simplified. I think the mechanism might be a bit different. The reason I am saying that is an experiment we did many, many years ago, and I hope that someone finally will repeat it.

We had divers that performed a deep saturation dive for a moment. And we measured their maximum breath-hold time and their diving response in terms of bradycardia before they did that dive and after. And our hypothesis was that their CO₂ sensitivity would be reduced because of reading of the dense scales.

What happened was that their CO₂ sensitivity was increased. Their breath-hold time increased significantly. And they had no diving response for up to a month after that saturation dive. So there obviously must be other mechanisms involved probably related to some kind of adaptation maybe in the sensitivity of, we speculated it could change the sensitivity of the breathing muscles or the muscles of the thorax that had a different input, would be one possible explanation.

I hope that that experiment can be repeated because it could determine the mechanism for the bradycardia. It is a bit more complex than normally stated based on that one single experiment.

I also want to make a point about the statement that it is not beneficial to have repeated hypoxias. We have done this experimentally in animals, by looking at the effect of repeated hypoxias to a height of 3,000 m [9,842 ft] two hours a day for six weeks. And we found a significant improvement in epithelial functioning if you do that. So there are various aspects to this.

DR. LUNDGREN: I suppose it would be somewhat difficult to do cognitive functioning in those animals. Be that as it may, as far as the point about the changes in the saturation divers, that is very interesting, although I am sure you are aware that one cannot necessarily say that the mechanisms modified by the saturation dive necessarily applied to people who never do saturation dives. But it is an interesting observation.

NITROGEN NARCOSIS DURING NO LIMITS FREEDIVING WORLD RECORD TO 160 M (525 FT)

Tanya Streeter

Freediver
Austin, TX, USA

Introduction

This is a case report from my 2002 world record dives to 160 m (525 ft) in No Limits and a couple of previous training dives.

Methods

The No Limits dives in which I experienced what I believe to be nitrogen narcosis ranged between 100-160 m (328-525 ft) in depth and utilized a weighted sled for descent and inflated liftbag for the ascent. Approximate travel speeds were $1.5\text{-}2\text{ m}\cdot\text{s}^{-1}$ round trip and the total times of 3:00-3:32 min:s. Prior to each dive, approximately 40 min of preparation took place, consisting of two shallow dives to between 15-25 m (49-82 ft) for 1:30-2:45 in time, and two short static apneas at the surface. The rest of the time was spent ventilating. During the descent of the final deep sled dives, the brake was used to facilitate easier equalization. I believe that I have also experienced brief narcosis on Constant Weight/Free Immersion dives to between 50-70 m (164-230 ft).

Results

The sensations of my narcosis were essentially the same on each occasion (approximately five instances total) and varied only in severity. On the worst occasion (at 160 m [525 ft] on a No Limits dive) I spent approximately 10 s unable to concentrate enough to operate my liftbag and was confused about what functions I had already performed. Once on the ascent, I felt severe numbness especially in my head and bit my tongue hard on purpose so that I could feel something. I do not remember a large portion of the first part of the ascent, until around 90 m (295 ft) or so.

Conclusion

My conclusion is that these feelings and symptoms were due to nitrogen narcosis.

PRESENTATION

MS. STREETER: Thank you very much. I appreciate very much the efforts that Dr. Lindholm and the organizing committee who have brought us together. It is really an honor for me to speak here, to follow Dr. Lundgren, who I never met, but have heard so much about, and also DAN and UHMS. I really want to thank everybody involved for bringing us all together.

We stand to learn a lot. We stand to be able to improve a lot in our performances. We are athletes first, so that tends to be our objective, and, obviously, to stay safe. So it is greatly appreciated.

I am going to discuss my experiences with narcosis. I thought a lot about how I would do this presentation, as intimidated as I am by the audience and what I can personally offer other than personal experience. So I decided that it would just be my personal experience that I would offer you. And rather than presenting a Power Point presentation or anything, I had the advantage of a film being made about this particular dive that I am going to discuss today. So I will show you that film which lasts in total about 20 min. There is a gap in the middle, which kind of gives me a good opportunity to say a few things about the first part of the film and what you can expect in the second part of the film.

Other than that, I will point out that it is a film. It was made by a United Kingdom production company in conjunction with the Discovery Channel here. Some of you may have seen it. I apologize if it is a little bit repetitive. However, from my perspective, being the subject of the film and living the training and the diving and everything as I was doing in 2002 when this was made, I thought that the real-life version was plenty dramatic enough, and was clearly irritated by how overdramatized and oversensationalized the film ended up being. But that is what audiences need in our world of channels being changed every three seconds; it has to be exciting the entire time, the attention deficit disorder television generation of which I am as well.

So I did not watch it. I watched it once. I was really irritated. I am irritated to the point where I got very, very upset about it. And I did not watch it again until I started thinking seriously about what I was going to talk to you about today. And when I watched it a few weeks ago, I actually, I was quite impressed. I mean, enough time has passed that I have forgotten a lot of the details of my own experience. So I thought, okay, it is not such a bad film after all.

I do just want to warn you, that, especially for this particular audience, there are things that the narrator says that are completely off the charts wrong. It does give you a good idea of how my experience is building up, how a record like this is put together. For those of you who do not know, it is a no-limits dive to 160 m (525 ft).

I had not discussed my experience with narcosis at depth publicly until about a year afterwards. When I say publicly, I just meant at dinner parties, mainly because I did not want my mom to know. I really did not.

As part of the rules, the iron rules of competition, the videos from the bottom and the top do get reviewed immediately after the record dive. There were a core group of people who saw what happened at the bottom. But what we were mainly focusing on was did I reach the bottom, was I assisted, and did I come back up myself. It was yes, no and yes. Nobody was particularly worried about the length of time I spent at the bottom and what you see on the tape.

When the film came out a few months later, I was a little bit scared about, you know, what people were going to say within the free diving community, whether my mom was going to pick up on it. She did not really, so that was okay. She was sitting next to me at the time going, and I am going, it is okay, mom, I survived. I am here. It is fine.

Retrospectively, I can say that I had suffered narcosis before this. My first no-limits dive I did suffer, I think, once, maybe twice. Kirk Krack was there. Sorry. I was rude to him afterwards because I did not understand narcosis so I did not know what was going on. My first public apology.

There was probably only two times after that that I suffered narcosis. Neither of them were on the sled. The sled has us upright, and they were dives when I was inverted and not going quite so deep. The temperature of the water was not any different. I have always done a lot of my diving in the

Caribbean, so I am spoiled rotten by the warm water. Perhaps I am not exposed to as many elements that can cause as much narcosis.

(The film was shown.)

MS. STREETER: Basically everything that sort of happened so far in the film happened – it is relatively realistic. The test that took place in the chamber was completed about six weeks before we got out.

MS. STREETER: My mom was very pleased at how much she made it into that film. I was just acutely embarrassed. So that is how it all played out. We did not discuss any of the effects of the nitrogen narcosis that I felt at depth.

Basically, my experience was, as you can see, it was a stressful dive. It was not quite as dramatic in terms of how it played out in terms of how I was progressing. I was a few feet away two days beforehand, but within a week, within a seven-day period, I did progress an awful lot because I was not hitting my target depths in training.

And the record was set on a Saturday at 160 m [525 ft]. On the Thursday, which is the dive I did before I did, 156 m [512 ft]. And on the Tuesday before that I did 152 m [499 ft]. But up until that point I was still – I cannot remember the depth. I just know it was less than the one I was trying to beat, so it must have been 135 or 136 m [443 or 446 ft]. So I made the sort of big leap of 20 m [66 ft] within just seven days of setting the record.

And then on the day itself, as you saw, anyway, I was nervous and stressed because it was record day, but I also had this momentary loss of consciousness right before I dived. And we reviewed the video time and time again, the surface video, and it was about 20 s between when I woke up to when I went again. I was very aware that everyone was in position, and I did not have time to prepare properly again, to relax completely again. Under the rules at that point in the sport, the Judge is only worried about blacking out after the record. There were not any rules about blacking out before the record.

I always say there is a thin line between trying hard and trying too hard. And as a good athlete, I butt up against that line but try not to go over it. I will be the first person to tell you that I certainly went over it that day.

I have a determination that I sometimes do not even understand in terms of what I am capable of doing. And on that day deciding in such a short space of time that I was still going to go for it, I do not know what process was going on in my head, but I did ask the Judge and the Judge said yes. So I took a quick breath, and I would estimate that I probably descended with about 75% of the lung volume that I would normally have done in a dive like that. I just did not have the time to prepare. I did not pack anything as much. I did not take initially as deep a breath as I would have taken.

During part of the descent, my first thought was what am I doing? We have tomorrow. There is no need to do this. Then my second thought, and I have this constant battle with myself on every dive, and I think a lot of free divers would confess to the same thing. I essentially decided that, okay, I will just treat it like a training dive and I will do the best that I can. Because everybody else was already in the water already doing the best that they can.

By the time I got to about 80 m [262 ft], I started to have problems equalizing. On a dive like this that is actually very shallow. I normally am able to equalize comfortably to about 110 m [361 ft].

When I did reach somewhere between 100 and 110 m [328 and 361 ft], and I did know this because my divers are stationed there, that is the point at which I stopped completely because I just could not equalize anymore. I recall being able to equalize just a little bit at that depth and making the decision to go on, and just see how far I can go. Because that is kind of what every training dive is like. I will just do my best and see how far I can go.

Consequently, the descent was a lot slower than normal. And then I did not equalize again between about 110 and 160 m [361 and 525 ft]. So I was in significant discomfort with my eardrums, not that much more than I expect I would have been, but, like I said, I normally have my last equalization around 130 m [427 ft]. So to have not equalized between 110 and 160 m [361 and 525 ft], my eardrums were already significantly bent in and compressed anyway, so there was quite a lot of pain.

The other thing that I think was probably the leading factor in why I stayed at the bottom so long and the confusion that I suffered was, we have a system. When we arrived at the bottom, I have three steps. My first step is to put my left hand on the lift bag because that way I know I am holding on to my ride back. My second step is to crank open the valve and start releasing air into the lift bag. My third step is to pull the pin.

It is very simple, it is one, two, three. We practice it time and time again on training dives. We practice it after a couple of glasses of wine. I am just kidding about that part. You would not drink during training. We just make sure that this is a habit, that we are going to do it no matter what.

When I arrived at the bottom, I had already decided weeks beforehand that I did want to spend a couple seconds there, maybe three, four or five seconds. I knew that I may never go that deep again. I knew I was always going to get asked the question what is it like. So I wanted to be able to give my best answer. I also wanted to do my little, romantic thing and blow a kiss to the sea.

When I arrived at the bottom, I went one, two, three. And I thought, okay, well, I have done three steps. That is when I knew I was not thinking very clearly. I waited and I thought, okay, well, I am not moving. I did not feel any physical sensations other than just not being able to think clearly.

I was going through the steps in my mind. Yes, I have done three steps. And I remembered back to three or four years previous when I did my first record, I was diving with a sled that used to stick. The top part of the lift bag used to stick on the aluminum pole, and we used to have to jiggle it a little bit, which is quite unnerving.

I thought maybe I am just stuck. That is the point at which you see me shake the bag a little bit. I thought maybe there is not much air in it. I was thinking but just not thinking clearly. I brought my fins up out of the wedge, the fin bin, and decided that I was going to try to push 90 pounds of weight back up to the surface.

The total time that I spent at the bottom was about 17 s. It looks a lot more on the film because that is what sells. But it was about 17 s, which is about 15 s too long, but it was, it was not as agonizing and long as it looks.

Finally, it was sort of like a light bulb went off, "Oh, pull the pin." Because I had opened the tank valve so much, I began to move a lot faster than I ordinarily would move. All of the clips of the ascent that you saw in that film are all from the record ascent. Then generally, it would move a lot slower. I would put enough air into it where it would just start moving, and I would enjoy the ride up and let it go slowly.

I, for one, believe, it is kinder on your body to return to the surface as slowly as possible. I would normally let go of the lift bag at around 150 ft [46 m] and then swim the rest of the way up. We are not out of breath on a dive like this. We are not burning a lot of oxygen. So we believe there is not the danger of blacking out for that reason. We believe it is kinder on your body to let everything return to normal in your body as soon as possible.

Having suffered the little crisis I did at the bottom, when I did leave the surface, as soon as I relaxed in the knowledge that I was on my way back up again I did start to have an overwhelming sensation of numbness in my whole body, so I actually bit down on my tongue very, very hard so that I could feel something in my body because I truly could not feel anything else except this pain that I was inflicting on myself.

And I remember very clearly leaving the bottom, and for probably about 100 ft [30 m]. But there is probably a good 250 ft [76 m] of travel that I do not remember at all. I would normally wave at my divers as I went by. I would normally give them a signal or I sense where the cameras and will do something funny. But I did not do any of that. I just held on for dear life. Retrospectively, I can tell you that I do not remember a significant portion of that.

Then probably around 100 ft [30 m], I noticed the light, and started to become aware of what was going on again. And, obviously, I am still holding onto the lift bag. Where I would ordinarily have reached back and released my safety clip, which is a line attaching me to above the rope on the lift bag, I was trying to reach back and release it. But it needs to be taut. And because I was holding onto the lift bag and not with my arms straight up, I was really gripping onto it because it was so full, I had my arms slightly bent so there was not the tautness on the safety line that I needed to be able to release it. From about 150 ft to 50 ft [46 m to 15 m], I was just trying to release the clip.

I was not feeling any sensation of narcosis anymore, but I could not release the clip, which is why I went whizzing past my husband. And I managed to release that and let go of the slack probably about 30 ft [9 m] from the surface and then swam up.

My sensations experienced at the surface was no different other than thinking, oh, my goodness, I am just glad that is over. I did not want to go do it again in the next day or two. My ears were painful, but other than that I felt completely fine.

I do not think there is anything else that I can tell you about that dive. The way I thought I would handle this is rather than give you information that you perhaps do not want or are not looking for was just to open it up to questions a little bit earlier than normal. I invite any questions that you might have that I can answer from my completely non-scientific, non-medical background.

WORKSHOP DISCUSSION

DR. BENNETT: You mentioned narcosis. The problem is that you take only one breath and you have only got 80% nitrogen. I do not think there are enough molecules of nitrogen to make you narcotic with nitrogen. I think what you are getting is the effect of hydrostatic pressure on your brain. And that starts to appear between 400 and 600 ft [122 and 183 m]. And it is a difficult one to recover from. You recover when you come up from the pressure, but the pressure itself will cause the problem.

MS. STREETER: Should it not happen on every dive then?

DR. BENNETT: Yes. If you go deep.

MS. STREETER: I have probably done between 15 and 20 dives over 100 m [328 ft].

DR. BENNETT: It is going to be about 500-600 ft [152-183 m], ideally.

MS. STREETER: I have suffered from that sensation between 150 and 200 ft [46 and 61 m] while in an inverted position. But I have not suffered from it every time I have gone over 400 ft [122 m]. Probably only twice, and I have been beyond that depth about 10 times.

DR. BENNETT: Well, I do not know. There may be some other explanation, but the most likely one is divers getting deeper and deeper to the 600 ft [183 m] level is HPNS. The CO₂ level, CO₂ narcosis, all kinds of things.

DR. LUNDGREN: Again, congratulations. This is the first time, certainly in front of a wider audience, that anybody has admitted to narcosis in breath-hold diving, which I think is extremely interesting. Now, these questions are not for you, but maybe we are allowed to also have an interchange between us here. I would like to ask this, since you brought up this interesting question, did this sound to you like a typical HPNS? To me it sounded like nitrogen narcosis. But this requires some rather involved quantitative calculations.

This is a situation where the nitrogen that is available is in the lung, and it is not that little, would potentially be the cause of narcosis. Do you know your total lung capacity?

MS. STREETER: When I did that dive, probably around 7.2 L.

DR. LUNDGREN: At any rate, it is compressed here. It is an amount of nitrogen that is not likely to be evenly distributed to the body tissues in the short period of time that you are talking about here. With a diving response, where the periphery is vasoconstricted the nitrogen would go mostly to the brain. And if you look at that, I bet you will find that there may be a very substantial brain PN₂.

The other aspect, and this is not a question but a comment – that I find pertinent here, is that, if this is nitrogen narcosis it answers a question that has often been raised. Namely, is it at all possible to absorb a significant amount of nitrogen from a lung that is severely compressed. The lung tissue follows the compression of the air, so that the exchange surface area normally about 70 m² between the lung blood and the gas space is reduced to an extremely small area. That could support the HPNS theory, of course, but it is most interesting that if you stick with the nitrogen narcosis theory for while, that here we have nitrogen being taken up, certainly on the way down, but very rapidly through a severely shrinking exchange area. I think you have provided some very interesting information. Thank you again.

MS. STREETER: Thank you.

DR. BENNETT: I agree. Just add some other factors. If you were to breathe compressed air from scuba or something like that, and certainly U.S. Navy and the British Navy did studies with breathing oxygen at 400 ft [122 m] plus and taking that away, going back to compressed air. And at 2.5 min they are unconscious.

We studied British Navy submariners experiencing very rapid compressions of the sort of thing you are doing because we want to get individuals out of those submarines very rapidly. We tested 400 ft

and 500 ft [122 and 152 m] compressed air with compression in 11 s. So it is pretty fast. And we had reaction time measurements.

There was no immediate reaction time change at 400 ft [122 m]. There was a decrement at 11 s, and 30 s later there was a decrement, which was significant. There is some narcosis at 500 ft [152 m] with a full compressed air situation, but not one breath. There was only just a small significance. It was not strong. So I still have my suspicions about nitrogen narcosis. I think it may be a combination effect.

DR. FEINER: I am not going to do the math to try to prove whether or not it is possible, because it is very complicated. Nitrogen is soluble, so that the pressures could build up pretty substantially. It is also likely that there is some hypoxia. At that depth with that loss of lung volume you are probably going to mix venous oxygen levels. Having experienced both nitrogen narcosis and oxygen saturations at 50%, the feeling is not that dissimilar. I think the higher CO₂ levels may lead you to be more susceptible to it. And I think from comparative physiology there is certainly a lot of belief that part of the reason elephant seals exhale is bulk susceptibility to the bends, susceptibility to shallow water blackout and nitrogen narcosis as well.

It is also very strange having experienced nitrogen narcosis with someone as a diving partner who has been diving for many years at 200 ft [61 m] in Fiji who does not even get it anymore, it is a very strange phenomenon. One of my colleagues Dr. Eager already proved, there is nitrogen narcosis at sea level, so we are already starting from nitrogen narcosis.

DR. DUEKER: I am an anesthesiologist. I am thrilled by your dive. It is really exciting. I think the only thing that is going to work is if you make several more to the same depth.

MS. STREETER: You are going to have to talk to my mom about that. She is not going to go for it.

DR. DUEKER: Aristotle was known for a lot of wisdom. One of the things he said was that one swallow does not a spring make. That is one dive like this, one experience like this, it is fascinating, very provocative, but I do not think we can say that it is narcosis. There are a lot of different things going on.

It is very difficult to imagine that nitrogen would become that much of a problem with that little bit that you had, really. So I think it needs to be studied a lot more. Very provocative, and I hope you do it a lot more.

DR. SMITH: I am a surgeon from Key Biscayne, Florida. I am just interested in diving. How long was the total amount of time down and up? How much actual squeeze do you feel in your chest and airway being that deep on a single breath of air? And when do you start exhaling on the way up, because there is more and more data showing that exhalation on the way up might be beneficial.

MS. STREETER: The total dive time was 3:32 min:s. I did not begin my ascent until about two minutes into it. That includes the 17 s or so I spent at the bottom. I was fairly quick to 100 m [328 ft], but I took slightly over one minute to go from 100 to 160 m [328 to 525 ft]. That part was really quite slow. And then the ride back up is about 90 s.

DR. SMITH: Did you feel a tremendous squeeze in your airway or your lungs?

MS. STREETER: You feel it. I do not know how to quantify that, but it is significant. I feel it, particularly around 80 m [262 ft] or so, and I do not think it gets much worse between 80 and 160 m [525 ft]. A little bit, but it is nothing like the change from 0 to 80 m [262 ft].

DR. SMITH: Do you have a protocol when you start exhaling?

MS. STREETER: About two meters [six feet] from the surface. At the point you feel like you are going to explode if you do not because we have this tremendous inhalation and then packing on top of it. As soon as we leave the surface, the pressure is relieved. On the way back up again, you build back up and can feel quite significant intrathoracic pressure.

DR. SMITH: The only reason I ask is there is a recent article in Science about penguins or seals or whales that really do a lot of exhaling very early up in their dive. If you figure your lungs are compressed down to a nub and as they start expanding, you are coming up quicker, you might wonder if it might be beneficial to exhale earlier.

MS. STREETER: Freediving, on the way up, we use every ounce of buoyancy that we can to help us. Not in this dive because we are using the lift bag. But in the other disciplines of diving where we are self-propelled, if not on the way down and on the way up, then certainly just on the way up again, it helps.

A year later I did a world record to 400 ft [122 m], riding a sled down and coming up self-propelled. In that particular instance, having kicked all the way up, I did not want to lose any buoyancy in the last few meters, so I did not exhale.

MR. KRACK: I am with Performance Freediving. I can attest to Tanya's first narcosis incident. I want to back Tanya up by saying that both Martin Stepanek and Mandy-Rae Cruickshank have also experienced narcotic episodes. We have lots of evidence of divers both in constant ballast disciplines, other than self- or sled-propelled, where the descent rates are approximately one meter per second. And we have seen that in cold water or darker environments that sometimes this can be enhanced, which would support a narcotic type effect, whether it is CO₂-enhanced or whatever. So there are a lot of other instances of narcosis with freediving.

DR. SOUTHERLAND: Two comments. Nitrogen narcosis, at least anecdotally, after long saturation dives in the Navy when the guys are coming out of the chamber, so they have been in a healing oxygen environment for a month, month and a half or so, and they come out and take their first breath of fresh air, a lot of times people will get slightly dizzy for just a few seconds. The thing that was thought was always, gee, you just have not been around the nitrogen. So just take a couple of breaths of nitrogen. I do not know that it is something that has been reported.

The other thing is in throwing in with everything else, could the effects that you have also be due to maybe a transient hypovolemia, from the fact that you have had all this blood, so now you are just not perfusing as well at least for a few seconds or so during the time. We see that in our hypovolemic losses from warm-water diving, the guys are coming out of the water. You do have shunting over a few seconds. So that is something to consider.

MS. STREETER: Thank you. That is a lot for me to take in.

MR. LANG: I am interested, and I may have missed your workup dives. On compressed air scuba deep science diving operations, we usually have a series of workup dives, especially to be able to gather quality data and deal with the narcosis. And we find that over a period of two weeks or so, we are getting fairly accurate between 160 and 190 ft [49 and 58 m]. This is on compressed air and scuba. I missed your workup dives. Are these in 10 or 20 m increments?

MS. STREETER: That is a really good question. It takes place over about four or five weeks. I dive every other day. We take a day off in between. Typically six months before the record I will decide on the depth that I am going to go to. And typically that is based on the competitor before me, what they have done. And I will have to go a minimum of two meters [six feet] more to beat them. So we work back from there. I think I was going to do 138 m [453 ft].

What was your record?

MS. CRUICKSHANK: 136 m [446 ft].

MS. STREETER: So I was going to go for 138 m [453 ft]. It was my husband's idea that I go for the men's record. I told him, if you want the men's record, you do it. He did not go for that.

But my point is, we set that target of 160 m [525 ft]. Well, he did on paper, and we worked back from that and we increased. Deeper we go in smaller increments. In the beginning, I think my first dive, we did two dives that day. My first dive would have been to about 50 m [164 ft] and the second one would have been to about 70 m [230 ft]. That would have been it until the following day. Then I think we increased in 10 m [33 ft] increments to 130 m [427 ft] or so, and then in 5 m [16 ft] increments. Overall, I think I did 17 training dives.

On the morning of the dive my preparation involves a little bit of stretching, not yoga. Whoever it was that said that we all did yoga was not correct. And that would take place on the shore. When I get in the water, I will breathe without the mask on just through the snorkel for five minutes. It is very relaxing and it helps me to refocus. I will do a breath-hold, breathe for about three minutes, then hold my breath for two or so, just to relax. Then I will do static apnea for 2:00-2:30 min:s. Then I will do a pull down to about 60 ft [18 m] and stay there for 1:30-2:00 min:s and then pull back up again, so very slow and relaxed. Then a couple of minutes rest. Probably another apnea. Breathe up for another three or four minutes. Hold my breath for around three minutes. Then relax for a few minutes. Breathe up for about four, pull down to 75 ft [23 m] or so, and stay there for between a minute to a minute and a half and then pull back up slowly. And then relax for a couple of minutes. Then we start the 10 min countdown and I go. And the 10 min countdown is very relaxed breathing at the surface, abdominal and chest breathing, just very, very relaxed.

MR. LANG: Do you feel measurable increases in your ability by doing the workup dives like that?

MS. STREETER: I do not know.

MR. LANG: Obviously, it is not an expenditure of energy because you are not actually swimming down.

MS. STREETER: When pursuing record dives in disciplines where you swim down, I do not increase in 10 m [33 ft] increments. I tend to increase in two or three meter increments. But my preparation on each dive day stays the same.

My preparation occurs before I even get to the water, I do a lot of cardiovascular work. I do very little conditioning, sort of breath-holding stuff. I do not like swimming pools, so I do not like to train in swimming pools. I do a lot of cardio, and then I go pretty much straight to my dive training.

Thank you very much for listening.

PHYSIOLOGICAL MECHANISMS INVOLVED IN THE RISK OF LOSS OF CONSCIOUSNESS DURING BREATH-HOLD DIVING

Peter Lindholm, M.D., Ph.D.

Swedish Defence Research Agency, Centre for Environmental Physiology,
Karolinska Institutet, Stockholm, Sweden

Introduction

A breath-hold diver has to avoid drowning by surfacing before hypoxia causes loss of consciousness. Unfortunately, breath-hold divers drown every year. Safe limits can be exceeded by employing various physiological mechanisms that enable individuals to hold their breath until syncope. This paper is a review of physiological mechanisms that may interact with ventilatory sensitivity to hypoxia or hypercapnia to increase the ability to breath-hold until loss of consciousness (LOC). These factors include: hyperventilation, hypoxia of ascent, fasting and prolonged exercise, and individual variation in the strength of the diving response.

Established Factors

Carbohydrate depletion: Prolonged periods of physical work deplete the carbohydrate stores (glycogen) in the body, which forces the body to compensate by increasing the rate of lipid (fat) metabolism. When the human body burns fat to produce energy, it uses 8% more oxygen than if it metabolizes carbohydrates. Also, 30% less CO₂ is produced by fat metabolism than carbohydrate metabolism. Thus, a breath-hold diver who has depleted his glycogen stores will become hypoxic faster, but the CO₂ driven stimulus to breathe will be delayed. A dive that could safely be performed in a rested and well-fed state may be dangerous after a long day of exertion from diving (11). A carbohydrate rich meal has been shown to reduce breath-hold durations (due to higher CO₂ levels and stronger urge to breathe from the higher RER) in subjects who had fasted for 18 h, suggesting that that the risk could be reduced by proper energy intake (13) and that breath-hold diving on an empty stomach may be dangerous.

Hyperventilation: Hyperventilation reduces the blood CO₂ content without increasing the oxygen content to the same extent, because the oxygen stores in the body are maintained constantly with normal breathing. Initiating the BH dive with a reduced carbon dioxide level makes it easier maintain breath-hold, enabling some divers with strong motivation (or a high tolerance to discomfort) to hold their breath until unconsciousness. Craig (3) showed that the prolonged breath hold times after hyperventilation were associated with lower oxygen levels in the blood going to the brain; these levels were low enough to cause hypoxic loss of consciousness. This was a particular problem if the diver exercised (swam) during the breath-hold.

Ascent blackout: The partial pressure of oxygen in the lungs (not the fractional percent) affects oxygen loading of the blood and therefore the oxygen delivery to the brain. A critical oxygen pressure (P_AO₂) of 30 mm Hg (values as low as 23 mm Hg have recently been reported (14) will sustain consciousness when breathing is resumed after a breath-hold (dive). At the surface, this equates to about 4% oxygen in the lungs and 45% oxygen saturation of the arterial blood. While a diver at the surface would be unconscious with an pulmonary oxygen content of 2% (P_AO₂: 15 mm Hg), a diver

swimming at 30 m (98 ft) with 2% oxygen in the lungs would feel comfortable, since the oxygen pressure would be 60 mm Hg (due to the surrounding pressure of four atmospheres absolute pressure). Recall Dalton's Law of Partial Pressure: the partial pressure of a gas equals the absolute pressure times the fraction of the gas: 4 ATA (3040 mm Hg) * 2 % oxygen = 60 mm Hg $P_{A}O_2$. This diver, who is still able to swim at 30 m (98 ft), would become unconscious during his ascent to the surface because the partial pressure of oxygen in the lungs would be reduced along with the absolute pressure. If we disregard the oxygen consumption of swimming, the diver will reach the critical oxygen level at a depth of 10 m (33 ft) where the absolute pressure is 2 ATA and the oxygen pressure will be 30 mm Hg (1520 mm Hg * 2% = 30 mm Hg). Thus, a breath-hold diver is most likely to suffer loss of consciousness near the surface during the ascent (5,6). The term 'shallow water blackout,' originally coined for CO₂ intoxication in diving with closed circuit breathing gear, is sometimes inappropriately used to describe hypoxia of ascent.

Diving response and oxygen conservation during exercise: The diving response has been shown to be highly variable among humans (10). These cardiovascular mechanisms may temporarily conserve oxygen during apnea with concomitant exercise (2,7,9) (i.e., temporarily reduce oxygen uptake in muscles). The strength of the response could be a factor, together with lung volume and swimming economy to render some humans more likely to survive long breath-hold dives. Inter-individual differences in bradycardia, vasoconstriction during exercise and apnea correlated significantly with arterial oxygen saturation (7); a stronger response resulted in a slower uptake of oxygen from the lungs. This effect was evident during both dry steady state exercise and immersed intermittent exercise concomitant with apnea (8). Thus it appears that certain individuals are able to reduce blood flow to the working muscles during apnea and thus conserve oxygen for the central nervous system that (unlike muscle) cannot function without aerobic metabolism.

Competitive diving: During competitions in breath-hold diving, most divers hyperventilate extensively and determine the duration of their breath-hold by means other than the hypercapnic ventilatory drive. Some seem to react to hypoxia via the urge to breathe, while others actively decide to abort the breath-hold when vision starts to falter, described as 'greyout' (personal communication with elite divers). While testing a group of competitive breath-hold divers performing static apnea, it was shown that end-tidal CO₂ was about 20 mm Hg prior to apnea (after 5-20 min of hyperventilation) and was still within normocapnic values, at around 38 mm Hg, upon termination of apnea (with breath-hold durations approaching five minutes). Subjects managed to surface without symptoms of severe loss of motor control (LMC) or LOC (12) exhaling gas samples with PO₂ as low as 23 mm Hg (14). Two subjects suffered LMC, exhaling samples of 20 and 21 mm Hg (14).

Putative Factors

There are other possible explanations for LOC during breath-hold diving.

Arrhythmia: The bradycardia triggered by apnea will result in various arrhythmias in humans (16), and it has been suggested that some individuals may be more sensitive to drowning accidents due to a mutation in a cardiac potassium channel (1).

Glossopharyngeal Insufflation: Breath-hold divers use glossopharyngeal insufflation (GI) 'lungpacking' to increase the volume of air in the lungs. This technique may cause syncope, most likely due to reduced venous return and therefore a loss of arterial pressure. There are numerous accounts of LOC with GI, with one incident where arterial blood pressure was measured simultaneously by finger plethysmography showing a loss of pulse pressure and thereafter LOC while performing GI (15).

Conclusions

Dejours (4) suggested that the urge to breathe may not be a safe determination of breath-hold duration, something that should be remembered, considering that much of today's teaching focuses on the safety of breath-hold diving as it regards CO₂ and hyperventilation. The general practice of discouraging hyperventilation prior to breath-hold diving will not make diving completely safe. Also, since competitive divers regularly hyperventilate prior to diving, the 'old' recommendations may fall into disuse. Education about the various mechanisms and safety procedures seems more beneficial for the future.

References

1. Ackerman MJ, Tester DJ, Porter CJ. Swimming, a gene-specific arrhythmogenic trigger for inherited long QT syndrome. *Mayo Clin Proc* 1999; 74(11): 1088-1094.
2. Andersson JP, Liner MH, Runow E, Schagatay EK. Diving response and arterial oxygen saturation during apnea and exercise in breath-hold divers. *J Appl Physiol* 2002; 93(3): 882-886.
3. Craig AB Jr. Causes of loss of consciousness during underwater swimming. *J Appl Physiol* 1961; 16(4): 583-586.
4. Dejours P. Hazards of hypoxia during diving. *Physiology of Breath-Hold Diving and the Ama of Japan*. Ed. H. Rahn. Washington, DC, Nat Acad Sci Nat Res Council, 1965: 183-193.
5. Lanphier EH, Rahn H. Alveolar gas exchange in breath-hold diving. *J Appl Physiol* 1963; 18: 471-477.
6. Liner MH, Ferrigno M, Lundgren CE. Alveolar gas exchange during simulated breath-hold diving to 20 m. *Undersea Hyperb Med* 1993; 20(1): 27-38.
7. Lindholm P, Sundblad P, Linnarsson D. Oxygen-conserving effects of apnea in exercising men. *J Appl Physiol* 1999; 87(6): 2122-2127.
8. Lindholm P. Severe hypoxemia during apnea in humans: influence of cardiovascular responses, Dissertation, Karolinska Institutet, 2002.
9. Lindholm P, Linnarsson D. Pulmonary gas exchange during apnoea in exercising men. *Eur J Appl Physiol* 2002; 86(6): 487-491.
10. Lindholm P, Nordh J, Linnarsson D. Role of hypoxemia for the cardiovascular responses to apnea during exercise. *Am J Physiol Regul Integr Comp Physiol* 2002; 283(5): R1227-1235.
11. Lindholm P, Gennser M. Aggravated hypoxia during breath-holds after prolonged exercise. *Eur J Appl Physiol* 2005; 93(5-6): 701-707.
12. Lindholm P. Loss of motor control and/or loss of consciousness during breath-hold competitions. *Int J Sports Med* 2006 Oct 6 [Epub ahead of print].
13. Lindholm P, Conniff M, Gennser M, Pendergast D, Lundgren CEG. Effects of fasting and carbohydrate replenishment on voluntary apnea duration in resting humans. *Med Sci Sports Exerc* 2006; 38(5): S384.

14. Lindholm P, Lundgren CEG. Alveolar gas composition before and after maximal breath-holds in competitive divers. *Undersea Hyperb Med* (in press).
15. Novalija J, Lindholm P, Fox JA, Ferrigno M. Cardiovascular aspects of glossopharyngeal inhalation and exhalation in breath-hold divers *Experimental Biology*, San Francisco. FASEB J 2006, 20(5): A1249.
16. Scholander PF, Hammel HT, Lemessurier H, Hemmingsen E, Garey W. Circulatory adjustment in pearl divers. *J Appl Physiol* 1962; 17: 184-190.

WORKSHOP DISCUSSION

DR. FEINER: Two comments and questions. As a father watching kids do breath-holds at swim meets, my interest has returned to breath-hold diving. The effects of hyperventilation start with the first few breaths. You increase the oxygen scores, alveolar PO_2 from 120 to 130 mmHg on the first few deep breaths while actually having minimal effect on CO_2 elimination. If we were to look at the CO_2 about 30 s later, it would be almost the same. And that improvement in oxygen store would actually be theoretically beneficial for safety.

I wonder if we switch to that, a few deep breaths is actually probably better because the breakpoint is likely to occur at a higher saturation. That is one comment. And these people that you are showing really are going at pretty steady state levels based on what their final CO_2 is at breath-hold breakpoint.

If you look at variation, I think it is always what makes people different, and you talk about variation in human apneic response. There is huge variation in ventilatory drives. The normal variation in hypoxic ventilatory drive and hypercapnic ventilatory drive are easily a three to four-fold range, with a huge difference in susceptibility. You showed differences in cardiovascular response. There is a reasonable chance actually that those responses are somewhat linked, and that the effect you are showing on saturation may also be related to a ventilatory drive. Have you studied the cardiovascular response and hypoxic and hypercapnic ventilatory drive in the same subjects?

DR. LINDHOLM: No. I have not studied hypercapnic or hypoxic ventilatory drive in those subjects. A comment on the other two things. Three to four deep breaths before breath-hold diving has long been generally recommended and is usually not considered as hyperventilation. As you point out, you get most of the benefit from the increased oxygen stores in the lungs from a couple of deep breaths. So the increase after that is, I guess, minor, but it is probably quite a bit anyway. It seems to be, why should they otherwise do it?

DR. FEINER: I think the competitive breath-hold divers' improvement in venous oxygen saturation is probably very, very significant and they are probably benefiting from that because they are going to extreme levels. Whereas most breath-hold divers in pools actually are not getting low enough to really extract from hemoglobin. So there are differences between safety and benefit at the extreme level. I would agree that there is probably significant benefit for hyperventilation for the extreme diver.

DR. LINDHOLM: A normal person that holds his breath usually breaks with over 90% saturation if they do not hyperventilate extensively, so they are nowhere near any hypoxia.

In terms of your comment on the variability of their ventilatory drive, Kirk Krack, who is sitting here, he told me of a diver he met who did not get any urge to breathe at all. He could just hold his breath until he passed out. So there are always going to be individuals. I do not know if Mr Krack wants to comment any more of that?

MR. KRACK. It is just he would not show any signs of hypoxia or even hypercapnia. One minute he is signaling you every 15 s and the next minute he is not. And there is no contraction. There is nothing. The only thing we could base his safety on would be signals. One minute he is there, 15 s later he is not signaling and he has blacked out. He cannot describe any idea of what is what is going on.

DR. LUNDGREN: What keeps him alive?

MR KRACK: We have come across a couple of people.

UNIDENTIFIED SPEAKER: So I was intrigued by these low end-tidal PCO₂s. I am wondering why do they end their breath-hold?

DR. LINDHOLM: The hypoxia produces a respiratory drive as well. It is not considered as strong as the hypercapnic ventilatory drive. But these two work in agreement together, and it has been studied in altitude medicine, for example. So you could say that they got hypoxic ventilatory drive that they get an urge to breathe from, but some of them use other cues.

I had one of the divers who managed to surface at 23 mm Hg, stating that he came up because he wanted to come up clean. He tried to do an extended breath-hold afterwards when he tried a little longer and he did not come up clean (unfortunately, he inhaled a little bit before he blew in the tube so we did not get that measurement). He showed signs of LMC.

None of these divers passed out during the experiments, but exactly how they know how to come up, you are free to ask. You have a few here in the audience. I have heard some say they feel something in the head, and some say the vision. And I know one that states that the grayout (vision) is not the end point, he can go a little longer than the grayout and still surface clean, he states that he then feel something in the head and if he goes past that, then he pass out. These are anecdotes. What exactly that refers to, I do not know.

UNIDENTIFIED SPEAKER: Is it possible that the end-tidal PCO₂s are not representing what is going on in the alveoli or the blood?

DR. LINDHOLM: End-tidal PCO₂s are supposed to be quite reliable in this situation (subjects do a maximal exhalation from a full lung volume after a breath-hold). In certain situations with an extended breath-hold, there is actually a reverse flow of CO₂ from the lungs into the blood since CO₂ is concentrated due to the shrinkage of the lung volume [Lindholm et al. 2002 EJAP].

DR. BENNETT: I want to come back to loss of consciousness and the lack of warning. I got involved with a case quite recently of a young boy who chose to breath-hold in a swimming pool where the people who should be watching, lifeguards, did not see him. Just laid underwater like that and held his breath. And he died, just like that. With no warning at all, no indication of change, like the apneic people here where they tap him on the shoulder all the time.

I would like the opportunity here to make one case that the one up, one down is very important in any breath-hold that is going on. You must have someone over the individual who is trying to breath-hold.

It is becoming in Europe, of course, very strong apneic sport, as they call it. And if it starts as I think it is beginning to start in this country, there is a lot of interest in breath-hold diving in a lot of areas. And we have to be very careful to have someone observing that individual because unconsciousness can occur very, very easily without warning.

DR. LINDHOLM: Yes, it is a teaching problem. There have, to my knowledge, not been any casualties among those who practice the competitive breath-hold diving according to the suggestions and rules of the sport. Whether they have had other accidents, we do not know. But there have been no accidents in organized competitions or organized training events or courses. They have a very strict safety protocol. Kirk Krack and his Performance Freediving team are going to talk more about this tomorrow.

DR. MACRIS: How do you explain the difference in the cognitive function of an athlete who is at the 50 to 60 mm Hg PCO_2 point where you describe the alteration in thinking and maybe fogginess and the patient with chronic lung disease that we see all the time who may be an engineer or a professional person who actually functions fairly well at a PO_2 of 50 to 60 mm Hg, although their PCO_2 is chronically elevated? How do you describe the difference?

DR. LUNDGREN: If I may interject. The chronic one is like the mountain climber who spends a month in base camp before going to the peak. Messner and Habeler climbed to the peak of Mount Everest with a calculated PO_2 somewhere on the order of 35 mm Hg, where other people would lie flat.

DR. MACRIS: There has to be an adaptive phenomenon. Have you looked at that?

DR. LINDHOLM: We have a presentation coming up where Lynne Ridgway is going to talk a little bit more about those cognitive effects. I think we should continue. I want to make a point that some of you may have thought of. It would seem like Peter Lindholm has put to rest or rather contradicted what our mothers told us. That you do not go swimming immediately after having lunch.

When we talk about food, perhaps we should be a little more precise and take note of what Peter said. It is a matter of what your RER is rather than whether there is food in your stomach. And mother might still have been right because if you have a very full stomach and go swimming, the pressure distribution of the body from the abdomen and outwards is conducive to regurgitation.

INCREASED LEVELS OF THE BRAIN DAMAGE MARKER S100B AFTER APNEAS IN COMPETITIVE BREATH-HOLD DIVERS

Johan PA Andersson, PhD¹

Mats H Linér, MD, PhD²

Henrik Jönsson, MD, PhD³

¹Department of Cell and Organism Biology, Lund University, Lund, Sweden

²Department of Anesthesiology and Intensive Care, Lund University Hospital, Lund, Sweden

³Heart and Lung Centre, Lund University Hospital, Lund, Sweden

Introduction

When observing competitions and record attempts in apnea, questions regarding the risks for brain damage easily come to mind. In four international apnea competitions between 1998 and 2004, the frequency of performances being disqualified due to loss of motor control or loss of consciousness was 4-9% (1).

S100B is a relatively brain specific, glial-derived protein, suggested to have several intra- and extracellular functions. S100B in serum is used as a brain damage marker as S100B levels increase after many types of brain damage. There is a correlation between the severity of ischemic lesions and serum levels of S100B (2). In addition to this late release, an early release has been observed. Whether this early release of S100B reflects a disruption of the blood-brain barrier or neuronal damage has been debated (3).

The possibility that a maximal-duration apnea results in a release of S100B from the brain to the blood has not been studied previously. Therefore, we investigated the magnitude and temporal patterns of serum S100B-changes after maximal-duration apneas in competitive breath-hold divers.

Methods

Nine competitive breath-hold divers volunteered to make a maximal-duration apnea during rest ('static apnea'). The entire experiment was performed with the subject in the supine position, including a 120 min rest period post-apnea. Preparations before apneas were performed according to each subject's normal routines, which usually included 'warm-up apneas' and extensive hyperventilation. The maximal-duration apnea was typically conducted after glossopharyngeal inhalation (lung packing). The subject was able to monitor breath-hold duration with the aid of a clock placed in the field of vision. Before the experiments, an arterial catheter was inserted in the radial artery at the wrist under local anesthesia. Serum levels of S100B and arterial blood gases were measured in samples collected before apnea, at the end of apnea, and at fixed intervals up to 120 min after apnea. Pre- and post-apnea S100B levels were compared using paired *t*-test. In six control subjects that did not perform any apneas, S100B in serum was measured at fixed times during a 120 min rest period.

Results

The divers held their breath for an average of 5:34±0:37 (range: 4:41-6:43) min. No loss of motor

control or loss of consciousness was observed after the maximal-duration apneas. Before the start of apnea, average arterial PO₂ was 128±9 (108-135) mm Hg, arterial PCO₂ level was 20±2 (16-24) mm Hg, and mean arterial blood pressure was 101±15 (72-120) mm Hg. At the end of apnea, arterial PO₂ was 28±4 (24-39) mm Hg, arterial PCO₂ was 45±4 (38-50) mm Hg, and mean arterial blood pressure was 143±25 (103-175) mm Hg. S100B in serum transiently increased within the first 10 min after the end of apnea (Fig. 1; +37%; p<0.05 compared to pre-apnea). Within 120 min, S100B levels were back to pre-apnea levels. In resting control subjects, S100B never increased above the starting level.

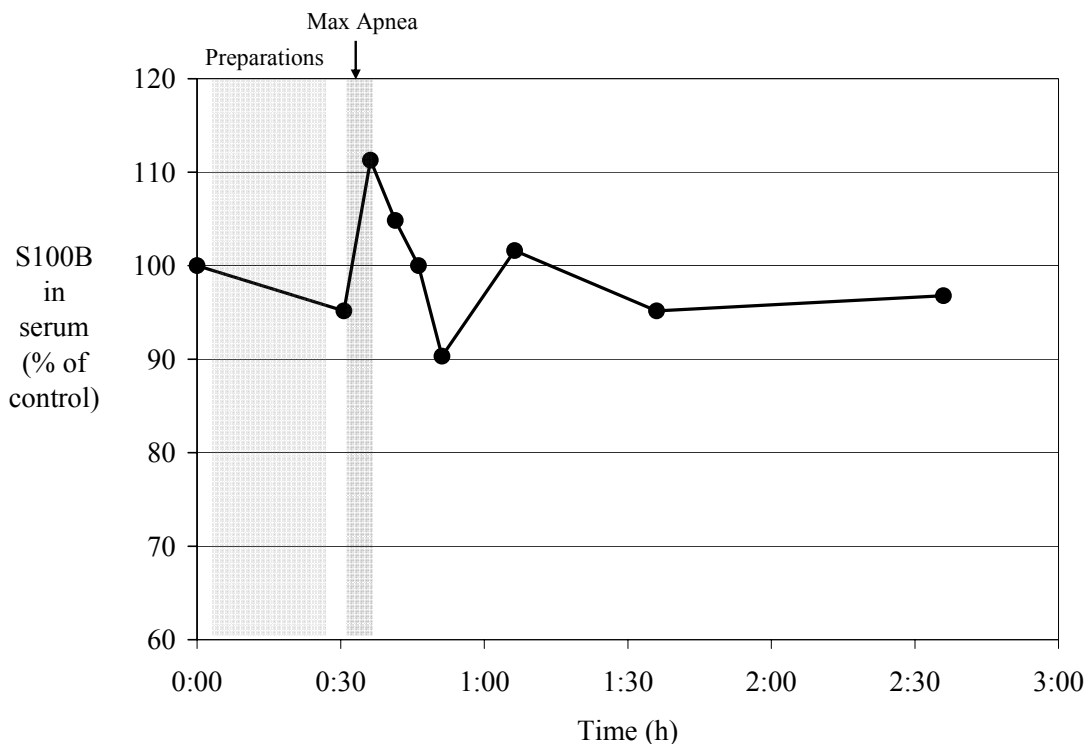

Figure 1: Changes in serum S100B during and after a maximal-duration apnea (n=9)

Discussion

The brain damage marker S100B transiently increases after a prolonged, voluntary apnea in competitive breath-hold divers. The precise mechanism(s) behind the increase is not established, and could involve both neuronal damage and a temporary opening of the blood-brain barrier. We attribute the S100B increase to the asphyxia or to other physiological responses to apnea, for example, increased blood pressure.

The clinical significance of the increase is uncertain. First, the S100B levels in the present study are well below those reported after, for example, ischemic stroke and hypoxic brain damage after cardiac arrest (2). The S100B can increase by several 100% in patients affected by such conditions. Second, the early pattern of S100B changes during the first two hours after various types of brain damage is not established. In the present study, the peak in S100B occurred within the first 10 min after the apnea. After traumatic brain damage and cerebral ischemia, the peak in S100B occurs within the first hours up to 1-3 days after the event (2). Unfortunately, we were not able to follow our subjects for a comparable length of time.

It is not possible to conclude that the observed increase in S100B levels in serum in the present study reflects a serious injury to the brain, although the results raise some concerns considering negative long-term effects. Ridgway and McFarland (4) found normal results in neuropsychological tests on 21 elite apnea divers. However, a long-term follow-up study on individuals at the beginning of their careers as competitive breath-hold divers and after some years of apnea diving would be of great interest to clarify these issues. Further studies are obviously needed for the risks for brain damage in competitive breath-hold divers to be properly evaluated.

References

1. Lindholm P. Loss of motor control and/or loss of consciousness during competitions in breath-hold diving. *Undersea Hyperb Med* 2005; 32(4):296.
2. Rothermundt M, Peters M, Prehn JHM, Arolt V. S100B in brain damage and neurodegeneration. *Microsc Res Tech* 2003; 60(6):614-632.
3. Kapural M, Krizanac-Bengez L, Barnett G, Perl J, Masaryk T, Apollo D, Rasmussen P, Mayberg MR, Janigro D. Serum S-100beta as a possible marker of blood-brain barrier disruption. *Brain Res* 2002; 940(1-2):102-104.
4. Ridgway L, McFarland K. Apnea diving: long-term neurocognitive sequelae of repeated hypoxemia. *Clin Neuropsychol* 2006; 20(1):160-176.

WORKSHOP DISCUSSION

DR. LINDHOLM: I have a question. Do you have any reference values, for example, other sports? We know that a lot of athletes use hypoxic tanks or high-altitude training. Has anyone measured S100B in terms of other sport performances?

DR. ANDERSSON: Well, there has been measurements in other sports as well; however, direct comparisons to competitive breath-hold diving I think is difficult with regard to those studies that were published, because those mostly involve traumatic head injury or whatever you should call it, like headings in soccer, boxing, running and so on, not hypoxic events. But it has been found that this brain damage marker increases also during soccer playing involving headings, also after boxing and so on. But I think then the mechanism is, what it releases is quite different. The magnitude of the increase is quite similar.

DR. LUNDGREN: Again, back to the soccer-playing kids that head the ball and then are determined to have cognitive problems down the road. It is very important to stress it because I think it is a generic problem, that the determination of mental function of one kind or another is, of course, no better than our diagnostic methods. And these kids for all appearance had not suffered any concussions. You do not feel like you have had a concussion or show signs of a concussion after hitting the ball a couple of times in a soccer match. And yet, as you stressed, the cumulative effect might be there and only show up after repeated insults.

DR. ANDERSSON: I think that is the main insight from the study. You see that we have a slight increase. But compared to acute conditions, it is a very slight increase.

DR. SMITH: This could be a normal physiologic response to severe stress. But unless you have got really long-term follow-up on cognitive function, I do not know that you could say that it is necessarily something bad. There are so many other things that change physiologically under stress. It would be interesting to know, have you ever measured free radical activity in the blood or change in blood pH, to correlate some of these other parameters?

DR. ANDERSSON: First of all, I would like to agree with you on your first comment. This is exactly what I wanted to point out. We cannot really say from this study that it is harmful. We just show that this brain damage marker increases, for what it is worth.

DR. SMITH: Do we know any more about the glial-derived protein? Do we know anything else about the specificity of the glial-derived protein? Could it have antioxidant or free radical effects? Do we know what it actually means by being released. I guess membrane cell damage like you suggested.

DR. ANDERSSON: As I said, we cannot really address the mechanism behind the release. But my guess would be that the blood-brain barrier is in some way impaired in its function so that the S100B that is found in the extracellular fluid leaks out into the serum. Whether or not that is something that could be potentially harmful in the long-term, I do not know, but at least that, to me, says that something is going on that is not within the normal physiology. The blood-brain barrier integrity is interrupted.

APNEA DIVERS: HYPOXYPHILIACS, ATHLETES, OR VALUABLE MEDICAL RESEARCH SUBJECTS?

*Lynne Ridgway, PhD cand¹,
Ken McFarland, PhD¹*

¹Neuroscience in the School of Psychology University of Queensland,
Brisbane, Queensland, Australia

Introduction

'Hypoxic brain damage' is a common diagnosis for patients referred for assessment and rehabilitation and is seen as the culprit for the cognitive difficulties experienced by patients with sleep apnea, chronic obstructive pulmonary disorder, and high altitude mountain climbers. Documented neuropsychological changes include poor memory, attention, judgment and decision making, visual and motor problems, headache and fatigue. However, animal models (3,4) and some clinical case studies (1,2,5,7) have found no cell death, or neurocognitive changes respectively following extended hypoxemia. Elite healthy apnea divers provide an excellent model of neuropsychological functioning following repetitive, long-duration pure hypoxemia in the absence of ischemia, illness or sleep deprivation confounds usually present in patients experiencing hypoxia.

Aims and hypotheses: To examine the long term or cumulative effects from repetitive long duration apneas with multiple negative neurological events (NNE = loss of consciousness or loss of motor control).

- 1) Elite apnea divers would demonstrate worse than expected performance on standardized neuropsychological tests compared to population normative data.
- 2) That there would be a cumulative effect such that those divers with the greatest number of years of apnea experience and/or reported over their apnea career would score lower on the neuropsychological tasks compared to their peers.

Methods

A literature review was conducted to examine the physiological and neurological adaptations involved in the 'mammalian diving reflex' and across similar hypoxic conditions in occupational, recreational, and medical conditions. A comprehensive neuropsychological evaluation of 21 English-speaking elite apnea divers participating in the 2002 Hawaii Pacific Cup of Freediving was conducted. A battery of tests with known sensitivity to minor alterations to brain functioning included basic neurological observations, estimates of premorbid intelligence, speed and accuracy of visuo-motor responding, speed of language comprehension, response inhibition, and visual and verbal attention and memory tasks. 10 Australian, 4 American and 7 English divers (12 males, 9 females) gave informed consent and were tested in conditions designed to simulate the competition environment to allow for repeat testing in later planned studies of the acute effects of apnea. None of the divers had engaged in apnea or in substance use for a period of at least 12 h prior to the testing. For a complete description of methods and procedures see Ridgway and McFarland (6).

Results

Divers were 31.0 ± 7.2 (mean \pm standard deviation) years of age, had 13.6 ± 2.0 years of education, 6.3 ± 6.4 years of apnea activity, 4.9 ± 0.23 min recent competition static apnea time, 111 ± 9 estimated intelligence quotient (IQ), and 5.1 ± 6.2 total number of lifetime NNE. Neuropsychological testing revealed that as a group, the 21 elite apnea divers performed tasks within one standard deviation of published norms adjusted for age and education. Multivariate general linear modeling revealed no significant correlations or group differences on cognitive functioning between the divers according to the number of previous NNE ($n=8$ with 0-2 NNE; $n=7$ with 3-5 NNE; and $n=6$ with >6 NNE) ($F_{(2,18)} = 0.47$, $p = 0.63$).

Discussion

These results suggest that 1-20 years of repeated exposure to hypoxemia and multiple negative neurological events including previous concussions, apnea related loss of consciousness and loss of motor control does not impact on cognitive functioning as measured by standardized sensitive neuropsychological tests. While no attempt was made to answer extraneous questions of hypoxiphilia we conclude that this group of elite athletes provides medicine with a valuable model to examine neuropsychological functioning in pure hypoxemia without the confounding effects of aging, ischemia, illness or sleep deprivation observed in other clinical models of hypoxia.

One explanation for this surprising result is that trained apnea divers may benefit from maximizing their adaptive response to low oxygen as predicted by the mammalian diving reflex and observed in physiological studies of mountaineers, clinical conditions and apnea divers. It was beyond the scope of this study to investigate if the mammalian dive reflex provides a mechanism for neuroprotection.

Alternate explanations for the null result are that the relative above average intelligence of this group of divers may have obscured any decline in cognitive functioning. Therefore, we would caution against assuming that an absence of statistically significant cognitive decline implies that multiple NNE does not cause persisting deficits in individuals. Further studies on the acute neurocognitive effects of engaging in long duration apneas with and without NNE are planned.

Acknowledgments

The authors would like to thank the organizers and participants of the 2002 Pacific Cup of Freediving for their immense support for this research.

References

1. Huckabee HCG, Craig PL, Williams JM. Near drowning in frigid water: A case study of a 31-year-old woman. *J Int Neuropsych Soc* 1996; 2:256-260.
2. Kemp AM, Seibert JR. Outcome in children who nearly drown: A British Isles study. *Brit Med J* 1991; 302:931-933.
3. Levine S. Anoxic-ischemic encephalopathy in rats. *Am J Path* 1960; 36:1-17.
4. Nagata N, Saji M, Ito T, Ikeno S, Takahashi H, Terakawa N. Repetitive intermittent hypoxia-ischemia and brain damage in neonatal rats. *Brain Develop* 2000; 22:314-320.

5. Perk L, Borger van de Burg F, Berendsen HH, van't Wout JW. Full recovery after 45 min accidental submersion. *Intens Care Med* 2002; 28:524.
6. Ridgway L, McFarland K. Apnea diving: Long term neurocognitive sequelae of repeated hypoxemia. *Clin Neuropsych* 2006; 20:160-176.
7. Thalmann M, Trampitsch E, Harberfelner N, Eisendle E, Kraschl R, Kobinia G. Resuscitation in near drowning with extracorporeal membrane oxygenation. *Ann Thoracic Surg* 2001; 72:607-608.

WORKSHOP DISCUSSION

DR. MUTH: Thank you very much for your presentation. This is a very exciting and important area of research, because we really do not know anything about long-term effects on the brain. Being diving doctor on one side and an anesthesiologist on the other, I am very interested in drowning.

You have to be very careful to compare those two kinds of diving, apnea diving and drowning, because all those cases where we had protective effects were associated to drowning. And it was not the blood flow itself, it was the transportation of low temperature to the brain, the cooling down of the brain which was protective, which slows down the metabolism. In all those cases where people drowned because of a heart attack, we have no protective effects. And only when the heartbeat was going on and transported cold temperature, cold blood through the brain, we have this effect. So be cautious to take this two-part. This is like comparing apples with peas.

'SAMBAS', 'MOOGLIES' AND OTHER ACUTE EFFECTS OF APNEA

Lynne Ridgway, PhD cand¹
Ken McFarland, PhD¹
Ian B. Stewart, PhD²
Andrew C. Bulmer, PhD cand³

¹ Neuroscience in the School of Psychology University of Queensland, Brisbane, Queensland, Australia

² Institute of Health & Biomedical Innovation, Queensland University of Technology, Brisbane, Queensland, Australia

³ School of Human Movement Studies, University of Queensland, Brisbane, Queensland, Australia

Introduction

Having established that there were no detectable long-term or cumulative effects on cognitive functioning in 21 elite apnea divers (3), we embarked on field and laboratory studies to examine the acute effects of apnea diving. Anecdotally, divers report that they occasionally experience a range of cognitive and motor disturbances post apnea including, language production disturbances ('Mooglie' – Canadian freedive team 2002), motor control problems ('sambas'), shallow water blackouts, difficulty with concentration or keeping track of time, feeling "fuzzy in the head" and not being able to recall events immediately prior to the apnea activity. This range of symptoms suggests a global change to neuropsychological functioning similar to that experienced by high altitude mountain climbers, pilots, and patients with clinical hypoxic conditions such as sleep apnea, or chronic obstructive pulmonary disorder (see Virues-Ortega et al. [6] for a review).

Aims & Hypotheses:

- 1) Field study: to assess the neuropsychological changes immediately following extended apneas. Based on the literature and anecdotal reports we predicted that divers would show a significant decline in neuropsychological functioning immediately following dynamic and static apnea events compared to baseline.
- 2) Lab study: to examine the relationship between performance on neuropsychological tasks and levels of hypoxemia attained during apnea. We hypothesized that there would be a strong positive correlation between oxygen desaturation during apnea and neuropsychological functioning immediately following apnea.

Methods

Both studies were approved by the University of Queensland Ethics committee, and volunteer participants received information sheets, and signed consent forms. Neuropsychological tests selected were the Symbol Digit Modalities Test (SDMT) (4), a four item explicit memory task, and a computer based simple reaction time task. Each test had multiple equivalent forms to allow for repeated testing. Physiological measures considered for this paper were heart rate, oxygen desaturation, and breath-hold duration. (Note: for full description of additional physiological methods see Stewart et al. [5]).

Field study: 67 elite divers (m=45, f=22), 31.2±7.2 (mean ± standard deviation) years of age and with 5.9±6.2 years of apnea experience from 22 countries were interviewed, then tested within five minutes post-dynamic and post-static apnea during the 2002 International Pacific Cup.

Laboratory study: Physiological and neuropsychological responses of 10 divers and 10 controls matched for age, education, and anthropomorphic variables, were examined during repeated face immersion apneas.

Results

Field study: During dynamic apnea competition, four of the divers suffered a brief loss of consciousness and two divers suffered a brief loss of motor control 'samba.' The 'sambas' involved a bilateral motor tremor, eye gaze deviation, and fine head bobbing lasting approximately 10 s, during which time the divers were fully conscious and able to follow commands. Baseline data from a subgroup of 21 divers (3) were used for comparison with 67 divers following dynamic apnea. They dived to 47.4±11.4 m (156±37 ft) depth. The average number of correctly coded symbols in 90 s on SDMT at baseline was 59.5±8.2, whereas the post-dive score was significantly reduced to 54.9±8.5 ($p<0.001$). No significant differences were evident on the picture memory or reaction time tasks. Data from 58 of the same divers after their static apnea (1-2 days later) resulted in neuropsychological performances not significantly different to baseline, SDMT score of 58.5±7.6. Again, there were no significant differences for the reaction time or the picture memory tasks. Data from three divers who suffered a 'samba' during the static apnea revealed SDMT performances that were significantly different to baseline ($t_{df=2} 26.0$, $p=0.001$) with subsequent recovery to baseline performance achieved within 80 min. One diver suffered a temporary blindness (approximately 30 min duration) and unilateral motor weakness following his 4:56 min:s static apnea and was not tested post-apnea.

Laboratory study: Compared to controls, divers had a greater number of previous negative neurological events (NNE; $p=0.02$), significantly longer maximal apneas ($p<0.001$), greater heart rate changes ($p<0.001$), and arterial oxygen desaturation compared to controls ($p<0.0001$) (Table 1, Figure 1). No group differences were found in peripheral blood flow, hematocrit, lactate, hemoglobin concentrations, or neuropsychological measures. However, divers with largest bradycardia demonstrated slowing of arterial oxygen desaturation two to three times that of other divers (5). There was a significant negative correlation between breath hold duration and arterial oxygen desaturation ($r=-0.840$, $p<0.01$).

Table 1. Differences between divers (n=10) and controls (n=10) on demographic, apnea, and cognitive variables

Parameter	Group	Range	Mean	SD	F _(df=18)	p
Age (y)	Divers	24-53	36.7	11.4	1.176	ns
	Controls	21-53	31.6	9.5		
Education	Divers	12-16	14.5	1.4	3.45	ns
	Controls	13-18	15.7	1.4		
NNE ¹	Divers	0-20	4.2	5.8	6.33	0.02
	Controls	0-2	0.2	0.4		
Years of BH activity	Divers	4-20	9.8	5.8	28.09	0.000
	Controls	0	-	-		
BH time (s)	Divers	182-301	246	44	39.8	0.000
	Controls	83-197	129	39		
S _a O ₂ (min %)	Divers	50-82	67	10	28.12	0.000
	Controls	75-94	86	5		
Heart Rate (beats·min ⁻¹)	Divers	23-49	41	8	0.772	ns
	Controls	25-68	45	11		
SDMT baseline	Divers	45-70	53.7	7.2	0.006	ns
	Controls	34-80	53.3	13.9		
SDMT post-breath-hold 5	Divers	42-65	52.5	7.1	0.276	ns
	Controls	42-74	54.6	10.5		
Picture memory/4 baseline	Divers	4	4	0	-	ns
	Controls	4	4	0		
Picture memory /4 post-breath-hold 5	Divers	2-4	3.7	0.67	2.8	ns
	Controls	4	4	0		
Reaction time - milliseconds at baseline	Divers	474-639	530	47	1.30	ns
	Controls	459-662	556	54		
Reaction time - milliseconds post-breath-hold 5	Divers	505-597	546	31	.004	ns
	Controls	481-597	545	39		

¹NNE includes previous concussion, head injury, diving related blackouts and 'sambas'

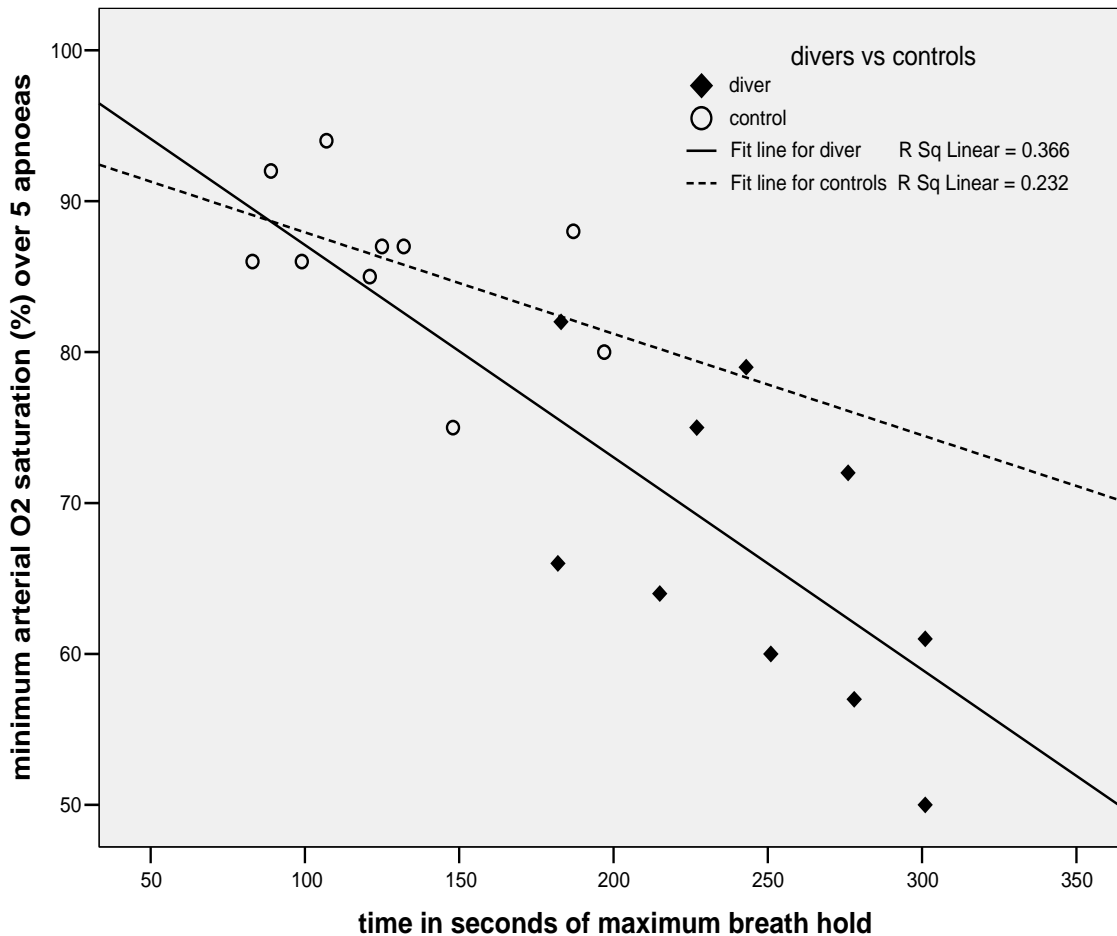

Figure 1. Minimum arterial oxygen desaturation as a function of maximum breath-hold time in seconds for n= 10 divers and n=10 controls.

Discussion

These two studies aimed to assess the acute cognitive and behavioral sequelae immediately following extended apneas. The first hypothesis that divers would show a significant decline in cognitive and motor functioning immediately following apnea compared to baseline was supported for the dynamic but not static apnea conditions. Apnea divers, immediately following a competition dive, demonstrated a significant decline in cognitive and motor speed compared to baseline. However, no differences were found on the simple reaction time or picture memory tasks.

These results provide support for the literature that apnea with exercise increases the desaturation effect and lactate accumulation (1) with consequent decline in speed of motor responding (2). An alternative explanation is that anxiety related to the dynamic apnea being on the first day of competition or first exposure to neuropsychological testing may have influenced performance on timed tasks. However, this is unlikely since if anxiety was a factor we would expect performance decrements on the reaction time task as well as the SDMT. A more plausible explanation is that the dynamic apnea despite being of shorter duration placed greater demands on oxygen usage than the longer duration static apnea without any exercise.

On the following day, divers' performances on the same neuropsychological tasks immediately following static apnea were not significantly different to baseline suggesting that a) static apnea does not produce the same neuropsychological difficulties as apnea with exercise, and b) divers had recovered from the neuropsychological decline evident post dynamic apnea. When three divers were examined following a loss of motor control their neuropsychological functioning showed further declines that had resolved within an 80 min time frame.

For the laboratory study, the hypothesis that there would be a strong positive correlation between oxygen desaturation and neuropsychological functioning was not supported, despite the fact that divers did experience a large desaturation effect (S_aO_2 $67\pm 10\%$) none showed a significant change to neuropsychological functioning on the sensitive tests used.

Conclusions

We conclude that even when apnea is (relatively) brief, if it is accompanied by exercise then neuropsychological and motor functioning is compromised. This effect is exaggerated further if the diver suffers a loss of motor control. However, recovery appears to take place within an 80 min period. Given our preliminary results we would recommend that divers refrain from complex cognitive and motor tasks such as driving a car for at least 90 min following apnea activities. This period is conservative and should be increased if the diver has suffered a NNE such as a loss of consciousness or loss of motor control. Further studies to examine the correlates between neuropsychological functioning and apnea during exercise are warranted.

Acknowledgments

The authors would like to thank the organizers and participants of the 2002 Pacific Cup of Freediving for their immense support for this research.

References

1. Ferrigno M, Ferretti G, Ellis A, Warkander D, Costa M, Cerretelli P, Lundgren CEG. Cardiovascular changes during deep breath-hold dives in a pressure chamber. *J Appl Physiol* 1997; 83:1282-1290.
2. Knight DR, Schlichting C, Dougherty JH, Messier AA, Tappan DV. Effect of hypoxia on psychomotor performance during graded exercise. *Aviat Space Environ Med* 1991; 62:228-232.
3. Ridgway L, McFarland K. Apnea diving: long term neurocognitive sequelae of repeated hypoxemia. *Clin Neuropsych* 2006; 20:160-176.
4. Smith A. The Digit Symbol Modalities Test - Revised. Western Psychological Services: Los Angeles, CA, 1982.
5. Stewart IB, Bulmer AC, Sharman JE, Ridgway L. Arterial oxygen desaturation kinetics during apnea. *Med Sci Sport Exerc* 2005; 37:1871-1876.
6. Virués-Ortega J, Buéla-Casal G, Garrido E, Alcázar B. Neuropsychological functioning associated with high-altitude exposure. *Neuropsych Rev* 2004; 14:197-224.

WORKSHOP DISCUSSION

DR. LINDHOLM: One comment. You do get sambas or loss of motor control even from the deep dives. It is just not as common in competition. It seems be, I think, my speculation was when I did the statistics on the competitions is that the divers seem to be able to sense when to come up. That is why so many manage to surface from the static apnea just on the edge of losing consciousness. But when you go for depth, well, you make the decision to surface long before you have any cues of hypoxia. So you can use that. So whether you reach the surface or not, you have to decide a minute or two earlier.

MS. RIDGWAY: I am interested too to know what the oxygen saturation levels are like while you are exercising. Presumably they are lower than when you are just doing a static.

DR. DUEKER: I would hate for people to get the idea that hypoxia from emergent accidents is not a problem and that the only problem in emergent accidents would be if your heart stopped. An awful lot of the data, and I use that in quotations, on emergent accidents are viable is, in a simple word, lousy. It is even worse than lousy.

And I was fascinated that you come from a neuropsych background because in what I consider a rather obscure neuropsych journal there is a marvelous follow-up study on a heroic survival of a near-drowning child. The child was in the water probably 40 min, cold water, full cardiac arrest. He made a perfect recovery. That is what is listed in the literature for 20, 25 years. Someone in neuropsych dug up – well, they did not really dig the patient up because the patient was still alive, but found the patient and ran the patient through a few neuropsych tests. Well, you do not even need to be a neuropsychologist to realize that the child had, no longer a child, had extreme learning disabilities, all kinds of problems. And yet, this child had been held up as a poster child for how good it is to drown in cold water.

So I just do not want people to go home and say, gee, this is fantastic or even more scary, to see it in the printed proceedings and we will end up with an awful lot of problems.

MS. RIDGWAY: I hope that is not what I am suggesting. And I am aware of that study [Hughes et al., 2002], and it is an excellent reminder of why we need follow-up neuropsychological evaluations as this young girl had clear MRI and MEG [magnetoencephalography] scans. She was submerged for 66 min and "recovered completely" but we know that children grow into damaged brains and the problems with frontal lobe executive functions do not appear until the child becomes a teenager and beyond. The longitudinal profile for this girl demonstrated a broad pattern of cognitive difficulties including global memory impairment. For this presentation I highlighted four of the studies of good outcomes that are in the literature on near drowning. There are several others with various outcomes.

[Boero JA, Ascher J, Arregui A. Increased brain capillaries in chronic hypoxia. *J Appl Physiol* 1999; 86:1211-1219.

Hughes SK, Nilsson DE, Boyer RS, Bolte RG, Hoffman RO, Lewine JD, Bigler ED. Neurodevelopmental outcome for extended cold water drowning: A longitudinal case study. *J Int Neuropsych Soc* 2002; 8:588-596.

LaManna JC, Vendel LM, Farrell RM. Brain adaptation to chronic hypobaric hypoxia in rats. *J Appl Physiol* 1992; 72:2238-2243.

Ridgway L, McFarland K. Apnea diving: long term neurocognitive sequelae of repeated hypoxemia. *Clin Neuropsych* 2006; 20:160-176.]

DR. LUNDGREN: Dr. Dueker's comment is well taken, but we have to be mindful of the fact that we are dealing here with samples where the N is one. There is another example in which a college student who drove through the ice with his car and was clocked as being underwater for 60 min and was then revived. After that he was an A-student. It does not say whether he was a C-student before the accident. But we should not draw conclusions from these isolated examples, as Dr. Dueker admonished.

DR. MULLER: Maybe just echo that a little bit. I would say that 30 min of visual motor symptoms is a relatively significant neuropsych finding. I have had the opportunity to take care of two individuals, closed circuit divers, who have had significant hypoxic events. And 90 min was not enough to let those guys return to work. They had neuropsych findings out at two weeks and 30 days. They were able to recover consciousness fairly quickly, but had persisting neurologic symptoms for two to three hours. So I would agree with that. There is something to hypoxia without ischemia that is causing, if not cell death, some fairly significant impact.

MS. RIDGWAY: It seems there are significant neurotransmitter changes. I wonder if the cognitive changes that I saw correlate with the S100B. I would love to look at such data.

DR. LINDHOLM: I would like to comment on that 30 min case. We know that you can get decompression sickness from breath-hold diving, and the symptoms that you report are with a 30 min span of neurological symptoms sounds very much like a DCI hit. And I think we are going to have a discussion on decompression sickness in breath-hold diving tomorrow by Dr. Wong and Dr. Koshi, and for this, I would just suggest that that symptom is probably not related to the hypoxia. It might be another interesting physiological phenomenon, but another one.

DR. FOTHERGILL: I do not know much about the rules for competition breath-hold diving, but do they provide any 100% oxygen after these hypoxia incidents to alleviate any potential problems.

MR. KRACK: Our standard protocol for loss of motor control or loss of consciousness would be 100% oxygen for five minutes on the surface.

DEVELOPMENT OF THE DAN BREATH-HOLD INCIDENT DATABASE

Neal W. Pollock, Ph.D.

Center for Hyperbaric Medicine and Environmental Physiology
and Divers Alert Network
Durham, NC, USA

Introduction

Divers Alert Network (DAN) has maintained a diving incident database since 1987. New cases are reviewed in an annual report. Summary statistics are presented and then anonymized thumbnail case reports are provided for further insight. The greatest value of incident reporting is to improve the awareness and safety of participants or those interested in participating.

Breath-hold incidents were not included in the original data collecting plan. Regardless, some were still submitted, so there was an accumulation of records over time. The growing interest in breath-hold diving worldwide made it clear that a dedicated effort to collect incident data specific to these activities was needed.

A breath-hold incident is defined as one involving a diver or divers wearing some equipment, usually mask and fins but with no gas supply, either self-contained or surface-based. The act of breath-hold does not have to be a factor in the incident. For example, victims could be snorkeling at the surface.

Retrospective 10 Year Review

The first effort was to review the breath-hold incident records available at DAN for a 10 year period, from 1994 to 2003, and then augment them with cases found through Internet searches for the same period.

A total of 131 cases had sufficient detail to include in this review. Most of the records were based on newspaper reports, often containing few details. Comprehensive records were available only for rare, high-profile events.

Ninety-eight percent of the cases involved fatal incidents. Non-fatal events were poorly reported. Eighty-eight percent of the victims were male. Victim age was 38 ± 16 (mean \pm standard deviation) years.

Seven problem patterns were identified: entanglement, diver-boat interactions, diver-animal interactions, solo/inadequately supported activities, behavioral errors, equipment issues, and impaired health and fitness. Details are presented in the 2005 DAN Annual Report, the first to include breath-holding data (2). Three case reports are included as examples.

Case Report 07/24/01 - An 18-year-old male was recreationally freediving with a friend from a boat anchored on a shallow ocean reef. The divers used a one-up-one-down system to monitor each other. After approximately one hour of alternating dives the victim made a dive to 60 fsw (18 msw). His

partner noticed that there was little movement during the first 30 s of the dive and became concerned at about 45 s. Anxiety compromised his freediving ability, and he was unable to reach the victim. County fire rescue divers recovered the victim after more than 20 min. He did not regain consciousness.

These freedivers employed a popular safety procedure to back each other up. Unfortunately, when the problem developed, the anxiety of the moment compromised the safety diver's performance. Ultimately, inadequate support became a contributing factor. There was insufficient information available to comment further.

Case Report 08/25/02 - A 14-year-old male was spearfishing with friends in approximately 65 fsw (20 msw). The victim was observed to develop difficulties while nearing the surface during ascent and began to sink. He did not release his weight belt and his companions were unable to reach him before he was beyond their reach. His body was recovered sometime later by divers.

This appeared to be a classic case of shallow water blackout/hypoxia of ascent. The first contributing factor was over-weighting. Ideally, his weighting would have kept him from sinking or had him sinking so slowly that he would have received help before descending beyond rescue depth. The second contributing factor was inadequate support, since timely assistance was not provided.

Case Report 08/17/03 - A 21-year-old male spent the day on a boat offshore participating in a variety of watersports. Towards the end of the afternoon he tied a speargun to a float and entered the water to do some spearfishing. He said he was going to go back down after one he had just seen. His friends on the boat became concerned when they saw that his float had not moved for an unspecified period of time. They found the loaded speargun still attached to the line. The victim's body was found two days later in 80 fsw (24 msw).

Facts are difficult to determine in unwitnessed cases. With no evidence of another problem, it is possible that hypoxia, either on the bottom or during ascent, played a role in this case. Inadequate support was a contributing factor.

The problem common to all three cases was inadequate support. Despite the presence of others in each scenario, the safety precautions proved to be insufficient. Incident data collection/reporting programs provide an important means to reduce the likelihood of similar events occurring in the future. Learning from the mistakes of others, recognizing the high risk elements of an activity, and stimulating personal planning of safety procedures sufficient for any given environment are all benefits of the effort. The growth of interest in breath-hold diving makes it appropriate to develop a system dedicated to this activity.

Inception of the Breath-Hold Incident Database

DAN supported the development of a breath-hold incident database in 2005. The goal was to capture more comprehensive data concerning both fatal and non-fatal events.

The database structure is open for evolution. Fields can be added and existing ones refined as additional issues or questions arise or new data become available. Currently, there are 234 fields under nine different sections (Table 1): incident time and location, personal data, health and lifestyle, experience, breath-hold profile and conditions on the day of the incident, incident scenario, equipment, medical examiner/coroner findings, and DAN medical examiner findings.

Table 1: Breath-hold incident database structure

Section	Field Descriptions
Incident Time and Location (20 fields)	standard information
Personal Data (19 fields)	age gender height weight body mass index (BMI) fitness (body composition, aerobic capacity, strength)
Health and Lifestyle (32 fields)	history of previous similar or related incident health history current health conditions medications lifestyle factors (e.g., smoking, alcohol, drug use)
Experience (18 fields)	training in breath-hold skill ranking (none, novice, intermediate, advanced, expert) breath-hold activity (past 12 months, personal bests - static and dynamic, current and lifetime) non-breath-hold diving experience (years of diving, certification level)
Breath-hold Profile and Conditions on Day of Incident (27 fields)	number of days in dive series number of dives on day of incident max depth on day preceding incident dive max depth of incident dive computerized dive profile(s) dive support (none/solo, partner, surface-based scuba, underwater divers) purpose/type of activity environment dive platform water conditions (sea state, current, visibility, temperature)
Incident Scenario (50 fields)	pre-dive technique (e.g., hyperventilation, lung packing, empty lung, inspired gas) dive problem (e.g., animal interaction, boat interaction, buoyancy, equalization, heavy exertion, shallow water blackout, entanglement, equipment) contributing factors (e.g., health, physical fitness, procedure/behavior, inexperience, inattention, insufficient training, poor planning, equipment check) trigger event (e.g., health problem, physical fitness, procedure/behavior, animal interaction, boat interaction, weather condition, equipment or dive problem) timing (when problem started, depth where problem started [if relevant], when witness became aware, recovery depth, recovery procedure)
Equipment (29 fields)	inventory of equipment used or available test of equipment function
Medical Examiner/Coroner Findings (17 fields)	external injuries diving injuries initial insult toxicology primary cause of death contributing factors major diagnoses incidental diagnoses manner of death
DAN Medical Examiner Findings (23 fields)	repeat of medical examiner/coroner findings fields plus additional coding fields

Many of the field descriptions provided in Table 1 are self-explanatory. Some are less clear or represent potentially more difficult to access data.

Fitness measures are difficult to secure. Body composition is best described by measures of hydrostatic weight or skinfold thickness, but such data are rarely available. Simpler measures will have to be relied upon for interpretation. Waist-to-hip ratio (WHR = circumference of narrowest level of waist / circumference of widest level of hips) is one example. The measure can provide additional insight to interpret body mass index (BMI = weight in kg / [height in meters]²) measures. Despite being widely used to comment on body habitus, BMI is not a measure of body composition. Individuals with relatively large muscle mass will also have high BMI values. A small waist-to-hip ratio would indicate that a large muscle mass was more likely to be present.

The rate at which oxygen can be consumed during maximal effort (described as aerobic capacity, maximal oxygen consumption or $\text{VO}_{2\text{ max}}$) and strength are important determinants of physical performance. Unfortunately, direct measures are rarely available. It is more likely that predictive test results will be utilized.

Predictive questionnaires can be used to estimate individual ability without direct measurement. The Houston test, for example, requires height, weight, age, gender and a self-assessment of regular physical activity during the most recent 30 days to estimate $\text{VO}_{2\text{ max}}$ (1). The activity level is selected from an eight-point descriptive scale. The data are entered into a simple equation to complete the estimate. The prediction is generally weakest for the least and most fit but often more reasonable for the middle fitness range. Practically, it is convenient to collect the data.

Personal performance records may be available in some cases, most likely for those actively involved in training or competitive activities. Meaningful physical strength measures will be more difficult to collect. It is possible, however, that simple evaluations could be collected following non-fatal incidents. For example, there are some normative data on pushup performance. This could allow some insight with minimal effort.

Experience and skill level are subjectively ranked, but in categories likely to provide fair self-categorization or categorization by a partner in fatal cases. Breath-hold performance records will be very useful, when available. Distinguishing between lifetime and recent performance records may provide useful insights. Static (resting) and dynamic (swimming) records are currently being targeted. Additional categories can be added as the available data directs.

Information on diving certification level and experience is sought with the intention of establishing a pattern of involvement in water activities. The expectation that many freedivers come from the diving population may change as the practice of freediving continues to mature.

The incident scenario currently includes the largest number of fields, starting with pre-dive protocols. Additional fields will be added as data accumulate and breath-holding practices evolve. The designations of dive problem(s), trigger event(s), and contributing factor(s) are flexible. Many elements will legitimately fall into more than one of these categories.

Finally, medical examiner/coroner reports will frequently be available for fatal incidents. Given the range of examiner experience with diving incidents, however, the reports may vary in utility. A protocol initiated with the original DAN accident database has fatal case documentation reviewed by a single medical examiner experienced in diving medicine (Dr. James Caruso). The review may, in some cases, produce findings different from those of the original examiner/coroner's report. This procedure will be applied to all captured fatal breath-hold cases.

Case Intake

The primary tool for identifying fatal incidents is the Internet. Automated keyword search strategies can be established to flag new reports as they appear. Follow up can be initiated once a case is identified, but complete records are often compiled slowly. For example, it can take one year or more to secure medical examiner/coroner reports.

Personal reporting of cases is less common, but is expected to climb as familiarity with the initiative increases. Personal reporting is essential for cases that are not available through the Internet, particularly non-fatal cases that receive no media attention.

Personal case submission will be facilitated by a web-based option. The form will be accessible through the DAN website. Relevant screen fields will appear as prompted by the entry of data. Non-relevant screens will not appear. Users will be able to append electronic files, such as dive logs, as part of the submission. Evolution of the web program will be guided by user input.

Non-fatal cases can provide a degree of detail not available for most fatal events. One recent case offered by a spearfisherman is described here to exemplify the comprehensive picture that can be provided. The principal in this case provided essential full field data after the incident, including narrative and electronic dive logs. Independent narratives were provided by other individuals present during the event.

Case Report 01/29/06 - A 41-year-old male was one of a group of four, spearfishing during a vacation in Hawaii. His current maximum dynamic breath-hold time was 2:30 min:s. His lifetime maximum breath-hold time was 3:15 min:s. The conditions were light seas, slight current, and visibility greater than 50 ft (15 m) on this first day of the trip. The incident dive was his 13th of the day, far deeper than his previous dives (Figure 1).

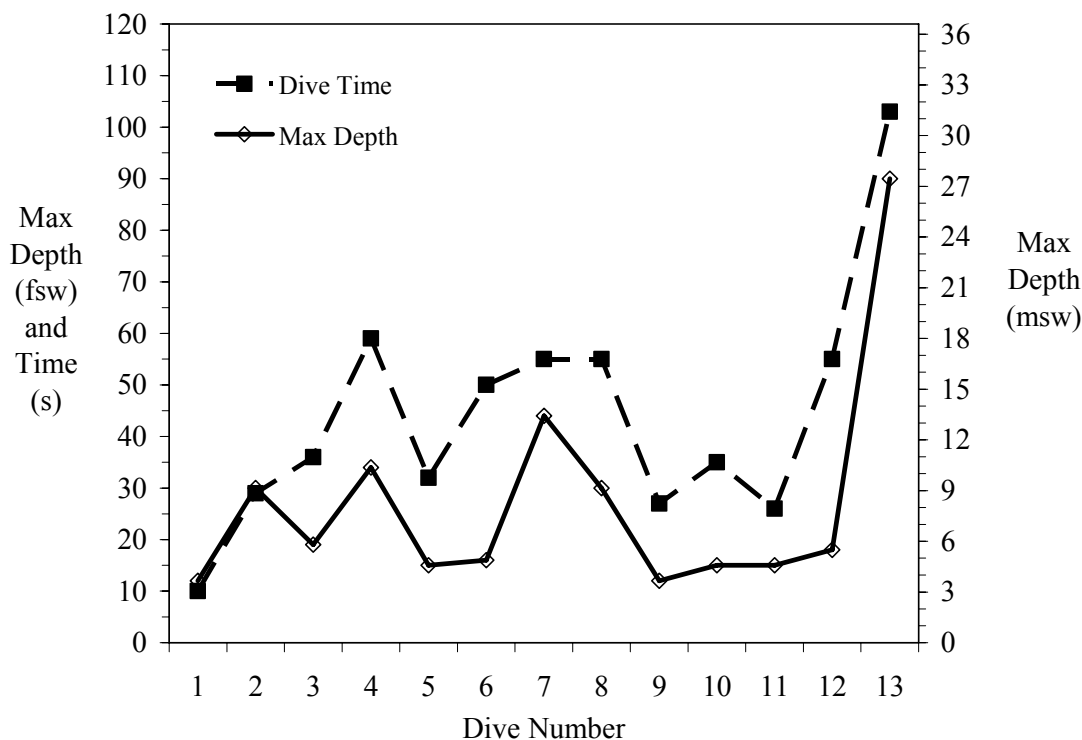

Figure 1: Freediving spearfisherman makes 12 modest dives (12-44 fsw [4-13 msw] depth and 10-59 s duration) followed by one more aggressive dive (90 fsw [27 msw] and 1:43 min:s duration).

The diver reported doing no hyperventilation before the dive, but described "several slow full exhalations and inhalations before taking a full breath." He planned to descend to approximately 60 fsw (18 msw) but the bottom was deeper than anticipated and he was approaching 90 fsw (27 msw) before realizing it. He paused briefly at his maximum depth to consider three fish targets but then decided they were not worth his attention and began his ascent. He chose to drop his speargun early in the ascent, since it was negatively buoyant and attached to his float line. He assisted his ascent with hand-over-hand pulling on the float line during part of the ascent. The effect of the hand-over-hand motion was evident in the 50-25 fsw (15-8 msw) range recorded by his wrist mounted dive recorder (Figure 2).

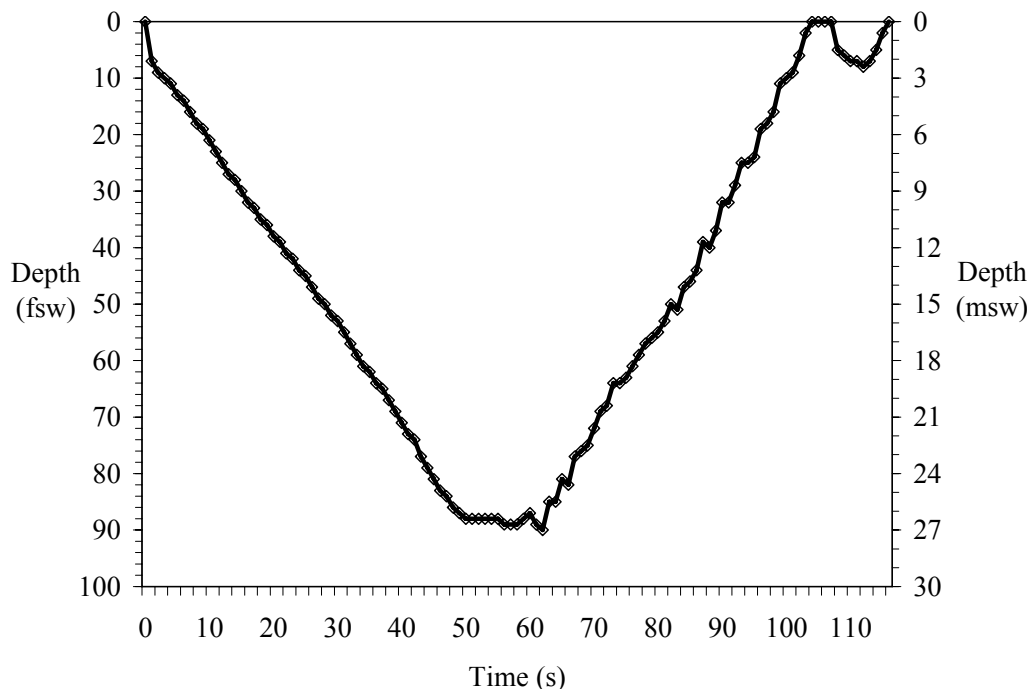

Figure 2: Freediving spearfisherman makes 13th dive of day to a maximum depth of 90 fsw (27 msw). He surfaced at 1:43 min:s, exhaled once, and then lost consciousness. He was rescued by companions after sinking to 8 fsw (2.4 msw) in 5 s.

The diver's narrative describes his perception of the end of the dive:

"I knew it was going to be a long haul, but I wasn't feeling much air hunger. As I passed 20 ft [6 m] I felt a little tired but relaxed. As I passed 10 ft [3 m] I knew I'd make the surface and began to relax a little. When I hit the surface, I blew out to take a breath, and then it was 'lights out.' I didn't feel it coming on at all."

The narrative of one of his rescuers provides a second perspective:

"I saw that he was fairly deep during the dive, so I kept my eye on him as he was coming up. I noticed he left his gun below and that he was ascending hand-over-hand on the tag line. He came up calmly, with no sign of anxiety. I swam towards him and watched him surface and then thought to myself that I had been overly concerned and started to swim away from him. I didn't want him to think I was crowding him. I was breathing up when I decided to take another look his way to make sure he was still okay. It was a shocking sight. He was unconscious below the surface of the water, in a T position, with arms straight out, his face slightly upward, one of his hands twitching, and he was sinking."

The diver sank to a depth of eight feet (2.4 m) in approximately five seconds. He was then pulled to the surface, his weight belt removed, and supported closely until he regained consciousness. Transient headache, slight nausea and some difficulty concentrating persisted for the next hour. There were no other complications.

This case highlights several issues. The diver was unfamiliar with the diving area, overweighted (22 lbs [10 kg] with a 7 mm wetsuit), and overconfident in his capabilities. Members of the group were aware of the importance of direct supervision post-dive, but did not employ it uniformly. Self-consciousness regarding supervision left the victim exposed and could easily have resulted in a much worse outcome. Finally, the poorly defined continuum between hyperventilation and 'deep breathing' or 'workup breaths' is subjective and potentially an unacknowledged source of risk.

Hyperventilation can be simply defined as a volume of gas exchange per unit time (i.e., minute ventilation) in excess of that needed to meet metabolic effort. The partial pressure of carbon dioxide in the arterial system ($P_a\text{CO}_2$) is reduced in response to hyperventilation. Reducing $P_a\text{CO}_2$ prior to breath-hold delays the time it takes for it to rise to the point of triggering a strong urge to breathe (hypercapnic drive). The well understood concern is that excessive hyperventilation can delay the hypercapnic drive long enough to make hypoxia a significant risk. Unconsciousness due to hypoxia can occur without warning. This is because our hypoxic drive is very much weaker than our hypercapnic drive. There is no 'toughing it out' with this problem. The diver in the current case passed out on the surface before inhaling, but it is also possible for unconsciousness to develop after a breath has been taken since it takes time for the newly oxygenated blood to reach the brain. This is why a full 30 s of direct supervision following every breath-hold is critical.

The practical concern increases when breath-hold divers claim to do no hyperventilation but, in fact, do so under the guise of other names. This situation may confer a false sense of security and makes it more difficult to capture potentially important data in the case of incidents. Considering hyperventilation as a dichotomous variable makes it easy to miss the possible influence of different grades of the practice.

The presence of support was critical for the positive outcome of this event. There is much less demanded of a rescuer if he or she only has to support a diver at the surface or recover them from a shallow depth. Close, direct supervision reduces the likelihood of needing assistance that exceeds the capabilities of a rescuer or rescuers operating under acute stress.

The most important feature of this incident report is the wealth of available data. The availability of dive profiles captured electronically at one second intervals, comprehensive narratives from participants, and subject availability for future questions make this a model of what can be captured for each incident. Such details provide insights far beyond the typical incident report.

Future Efforts

Success of the breath-hold incident database initiative requires support from the breath-hold community. While many fatal cases will be identified through automated Internet search procedures, personal submission is expected to reinforce the identification of fatal cases and as the prime mechanism to collect details concerning non-fatal cases.

Summary reviews will be released every year as part of DAN annual reports. Case series will be released as they are accumulated; offered to relevant publications to educate and encourage contribution to the data collection effort.

Conclusions

The DAN breath-hold incident database is available to capture both fatal and non-fatal cases. The accumulation of details not readily available in most news releases is expected to provide a useful tool to improve awareness, facilitate training and promote procedural review and development.

Acknowledgments

Julie E. Ellis, Sheila J. Modi and Jennifer L. Wiley for support in data collection and data management.

References

1. Jackson AS, Blair SN, Mahar MT, Wier LT, Ross RM, Stuteville JE. Prediction of functional aerobic capacity without exercise testing. *Med Sci Sports Exerc* 1990; 22(6): 863-870.
2. Vann RD, Freiburger JJ, Caruso JL, Denoble PJ, Pollock NW, Ugucioni DM, Dovenbarger JA. Report on Decompression Illness, Diving Fatalities and Project Dive Exploration: DAN's Annual Review of Recreational Scuba Diving Injuries and Fatalities Based on 2003 Data; 2005 Edition. ISBN 0-9673066-7-1. Divers Alert Network: Durham, NC, 2005.

WORKSHOP DISCUSSION

DR. LUNDGREN: I notice that the mean age for the cases you have so far was 38 years. Do you at this time have any impression as to whether these incidents are preferentially in the higher age group or not? Of course, it has to be looked upon in relationship to how many of any age group engage in breath-hold diving, and that is a hard data to come by, I am sure.

Let me explain why I am asking this question. We pointed earlier to the occurrence of cardiac arrhythmias in breath-hold divers. And one of the ravages of old age is that one becomes more prone to arrhythmias. So it would be very interesting to see if those cases or accidents which cannot clearly be connected with a shark bite or a crocodile chewing on you, et cetera, the unclear cases whether they are concentrated in the higher age group because that could support the notion that indeed there are some ill effects of breath-holding in terms of cardiac function that probably is more likely to hit the older diver than the younger.

DR. POLLOCK: Excellent comment. We do not know the denominators, so we do not have that answer now. I think that would be something we could consider as we accumulate more non-fatal cases. If we see a big discrepancy in the ages between the non-fatal and the fatal cases, it will raise suspicion. Right now, it looks like the breath-hold population seems to be maturing like the diving population is. We do not have as many young people. But we need additional data.

DR. LUNDGREN: Is there any information to indicate how breath-hold diving is divided over the age groups in general?

DR. POLLOCK: We do not have that information now. We are going to have to see if others have collected such data. It may be that market research could help answer the question.

DR. KAY: Instead of BMI [body mass index], a better tool might be the NOAA gender-specific body fat index calculations. I have done a number of the NOAA physicals, and they all require you measure the neck and natural waist. So they are a bit more specific with regard to gender.

DR. POLLOCK: There are several tools that employ simple measures. The NOAA protocol relies on height, weight and several circumference measures to estimate body composition. A major limitation

that afflicts most of these tools is that most of the normative data were collected in the 1950s and 1960s, and may not be as representative of the current population.

We do have to continue evaluating alternative strategies. When we complete anthropometric measurements in our lab, we enter the data into a battery of standardized formulae so we can see how well they fit. Unfortunately, while several of the techniques provide seemingly reasonable group averages, they are often fairly weak on an individual basis.

We would be happy to consider additional suggestions. The caveat is that we have to be sure not to discourage participation by asking for too much.

DR. SCHAGATAY: My question has nothing to do with physiology or reporting, but it has to do with prevention. I was in Italy in a conference a year ago where we were working it out to try to have divers use buoyancy equipment or floats. Just from your case reports, it was obvious that very often divers have a body but they can not do anything with it when they lose it because it is too late. Is that something that DAN is doing and in what way?

DR. POLLOCK: Thank you for that comment. The afternoon session is largely dedicated to safety, with victim recovery as an important element. You will hear Dr. Maas speak about some equipment that has the potential to reduce the risk of failed recovery. We would certainly like to see efforts in this direction move forward.

DR. SOUTHERLAND: Do you have a data dictionary set up for someone filling the form out? Defining, for example, hyperventilation and shallow water blackout. I do not know if there is universal agreement on certain definitions.

DR. POLLOCK: The data fields are currently set up in an Excel file that I have been sending out to individuals offering to review the structure or submit cases. There are drop down menus with thumbnail definitions. Most fields are defined. The definitions will be refined, and new variables added, as experience and input direct.

DR. SOUTHERLAND: One other thing, the Navy has recently gone over to WESS [web-enabled safety system], a web-based database for entering accidents. If you have got a helicopter accident or diving accident, you start off with the same thing. Right now for the diving side it takes anywhere between 30 and 40 screens, web pages, one has to go through to enter in the data. We found out that people are not reporting cases even though they are required to. Web forms are not effective if they are too long.

DR. POLLOCK: We are trying to avoid similar problems by having specific fields appear only if a positive flag is entered to warrant further questions in that area. We will try to minimize the number of pages that a person has to go through.

DAN BREATH-HOLD INCIDENT DATABASE: 2004-2005 CASES

*Sheila J. Modi, B.S.^{1,2}
Neal W. Pollock, Ph.D.^{2,3}*

¹ University of Texas Medical Branch, Galveston, TX, USA

² Center for Hyperbaric Medicine and Environmental Physiology
Duke University Medical Center, Durham, NC, USA

³ Divers Alert Network, Durham, NC, USA

Introduction

Breath-hold diving is gaining popularity as an underwater sport. Breath-hold diving refers to in-water activity without the use of scuba or surface-supply breathing gas. Participants have a narrow time window in which to operate before oxygen depletion increases the risk of serious injury or death. The risks associated with breath-hold vary according to individual practice. Examples of practices unique to breath-hold include hyperventilation prior to breath-hold, which can result in hypoxic loss of consciousness, and lung packing, which can lead to pre-breath-hold syncope and an increased risk of overexpansion lung injury. Development of a formal program to collect and disseminate information regarding breath-hold injuries and fatalities is desirable to improve awareness, training, and procedural development.

Methods

Divers Alert Network (DAN) created a database in 2005 to capture breath-hold diving incident records for both fatal and non-fatal cases. This report summarizes cases found to have occurred in 2004 and 2005.

Data are presented as percentage (%) and/or number (n) of cases, or as mean \pm standard deviation with range, as appropriate.

Results

Thirty-seven breath-hold incident cases contained sufficient data to include in this review. Victim age was determined for 95% of cases (n=35). Age was 39 ± 15 (14-77) years (Figure 1).

All but one of the recorded incidents involved fatalities. The one non-fatal case was a shark attack in Hawaii. A spearfisherman was alone in water shallow enough to stand in, swimming back to shore on the surface while towing his speared catch in a bag 30 ft (9 m) behind him. He was not aware of the shark until he was bitten on the shoulder. He was able to discourage the 12 ft (3.7 m) long animal during a second pass by striking it with his speargun. Initially unwitnessed, he was able to attract help after swimming closer in to shore.

All but one the victims were male. A woman died after being struck by a speedboat propeller while snorkeling from a day boat in or possibly just outside a marine reserve area off Redang, Malaysia.

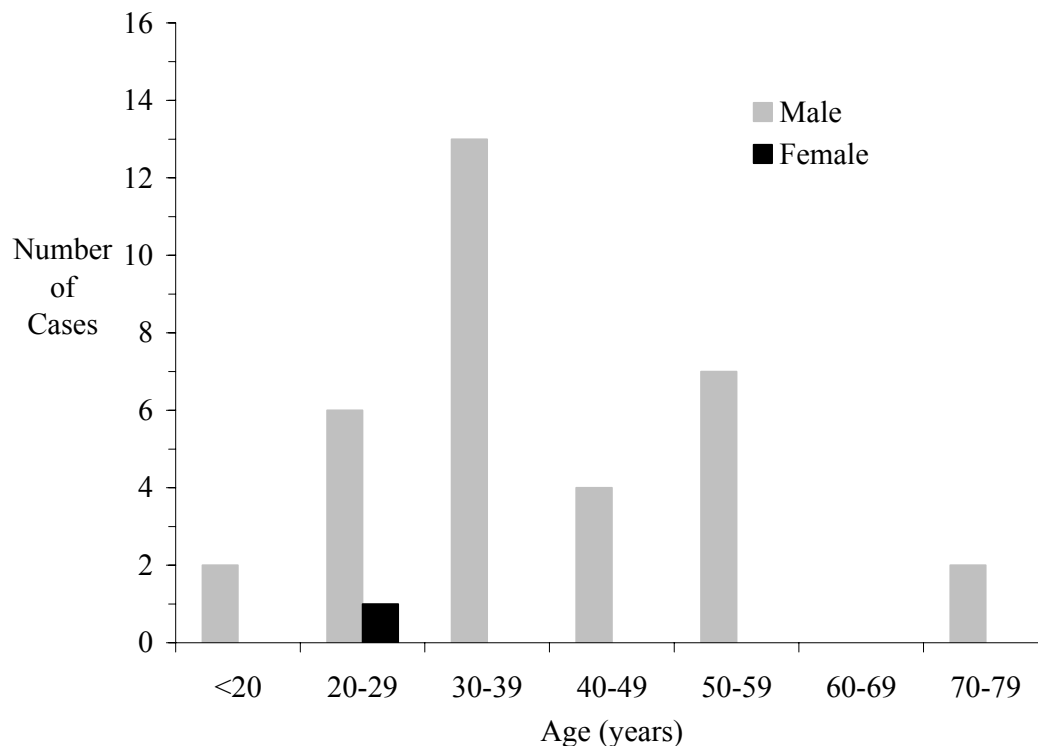

Figure 1: Age and gender distribution of breath-hold incident victims. Mean age was 39 ± 15 (14-77) years.

The breath-hold activity at the time of the incident was available for 95% of cases (n=35). Activity was described as snorkeling (34%), spearfishing (29%), collecting (20%), or freediving (17%). The classification of activity was often somewhat arbitrary, based on the degree of awareness of the reporting parties.

Dive support was determined in 89% of cases (n=33). Support was described as partner (55%), none/solo (21%), group (18%) or other (6%). The dive platform used was determined for 84% of cases (n=31). Dives were primarily conducted from shore (45%) and day boats (39%). Most cases (85%) referred to dives conducted in ocean water.

Information on eyewitness presence was captured in 86% of cases (n=32). Eyewitnesses were present for 47% of incidents. The availability of assistance was captured in 89% of cases (n=33). Assistance was available to victims in 55% of incidents. Victim recovery was confirmed in 81% of cases (n=30). Victims were recovered in 90% of known cases, most commonly from the bottom (40%).

Information on contributing factors (e.g., behavior, procedure or predisposition) was seldom available. The trigger event was established in 35% of cases (n=13). These were classified as animal interaction (42%), weather condition (25%), health problem (17%), boat interaction (8%), and dive problem (8%). Evidence of shallow water blackout was found in 19% of cases (n=7).

Discussion

The 37 cases available for this review likely represent only a fraction of the total number of breath-hold incidents. The shortfall is undoubtedly greatest for non-fatal events, which are rarely reported.

Sufficient data were found for the available cases to allow description of basic trends, such as breath-hold activity, age, gender, and the presence of dive support. While some data regarding contributing factors and trigger events were obtained, more information is needed for comprehensive analysis. Case records are rarely complete. Greater participation in the reporting program by members of the breath-hold diving community is required to increase the strength of the data. Currently, access to follow up records, particularly for fatal incidents, involves substantial delays that limit the ability to provide timely summary reviews of case files.

Conclusions

While a small number of high profile fatality cases may be widely reported, limited information is available for most breath-hold incidents. Non-fatal events are rarely reported. Details of individual cases could provide valuable insights to improve diver awareness and safety. DAN will continue the effort to collect information on both fatal and non-fatal breath-hold incidents. Data collection will be facilitated by an electronic submission option accessed through the Internet. Regular release of anonymized summary reviews will be used to increase awareness of safety issues and to promote continued support of the program.

Acknowledgment

SJ Modi worked on this project while completing a research elective in the Center for Hyperbaric Medicine and Environmental Physiology at Duke University.

WORKSHOP DISCUSSION

MR. KRACK: I think it is important that we be very careful when we are talking about diving with a buddy, as opposed to direct supervision. Buddy diving might find the partners several hundred feet apart. Direct supervision has us close enough so that we can maintain an airway if needed. We watch our subject closely for 30 s on the surface for any delayed problem. I think it will be important for the database to ask not just if buddies were present but whether direct supervision type procedures were being practiced.

MS. MODI: That is a good point. We will add that distinction.

MR. LANG: Forty-seven percent of the incidents were animal interactions. Should not the number of questions in the database somehow be correlated to that?

DR. POLLOCK: A point of clarification. The 47% referred to the number of cases in which animal interaction was established as the trigger event. The trigger event was only established in approximately 30% of cases. Animal interactions were associated with a total of 15% (eight out of 51) of all events. It is the evidence left in many of these cases that makes the cause relatively easy to establish. The records are incomplete for many of the cases we have identified.

DR. SHANK: I would like to have you define what incidents – obviously, fatal incidents it is fairly easy and animal attacks, but for near-miss type events, what are you hoping people will report? The case that Dr. Pollock described of the diver who lost consciousness after surfacing and sank was obvious. But what about someone who lost consciousness at the dock afterwards or developed subtle neurological symptoms post-dive?

MS. MODI: The reporting of all cases will be encouraged. We can learn from each.

DR. POLLOCK: We rely on the support of individuals who will submit cases. Our hope is to increase awareness so that any incident requiring intervention by an outside party, involving a change of level of consciousness, or leading to an unanticipated change in activity or practice would be reported. Beyond that, if it is noteworthy to those involved, we can capture it and perhaps identify new issues before they cause bigger problems.

DR. BUTLER: I was interested in your Internet triggers, the automatic updates of the events that happened. I know that many newspapers are reported online. Are you able to tap into almost every big city newspaper and hopefully many small newspapers and automatically capture stories of breath-hold events that occur?

MS. MODI: We are. The Google Alerts flag stories from a wide range of publications. We can then use the Internet to try to identify more detail. Some police reports are available online, for example, most notably in Hawaii.

DIVING HABITS HISTORICALLY ASSOCIATED WITH 'SHALLOW WATER BLACKOUT' IN HAWAIIAN FREE-DIVERS

Richard W. Smerz, DO

Frank Farm, Jr.

Hyperbaric Treatment Center, University of Hawaii, John A. Burns School of Medicine,
Honolulu, HI, USA

Introduction

Fatalities occur yearly among freedivers. Hypoxia of ascent, commonly coined as 'shallow water blackout' (SWB) by freedivers, may be an underlying cause for many of them and pre-dive hyperventilation has been historically implicated as a contributing factor to SWB (1,2). This study was conducted to assess diving practices which have historically been linked to SWB in an attempt to better define the degree and nature of the problem.

Methods

A self-reported, anonymous survey to obtain information regarding diving habits and practices as well as experiences with symptoms suggestive of SWB was administered to a population of avid and active freedivers in Hawaii. Questions solicited information regarding age, gender, total years of freedive experience, frequency of diving, average dive depths and times, knowledge of SWB, hyperventilation practices, and experience and circumstances associated with near or frank SWB. Information was evaluated for the entire population initially. Then the population was divided into two groups based upon whether the respondents had experienced symptoms (severe lightheadedness, near-syncope, unconsciousness) suggestive of SWB or not, and reanalyzed for any differences between them. Data are presented as mean (\pm standard deviation) with range as appropriate. Statistical significance testing between these two subgroups comparing average age, average number of years diving, average days diving/month, average dive depths, and average dive times was done using the paired *t*-test at the 95% confidence level. Chi square was used to assess any significance of differences in the proportion of hyperventilators in the symptomatic and asymptomatic subgroups. Statistical significance was accepted at $p \leq 0.05$.

Results

One hundred thirty-six freedivers provided survey data. Subject characteristics are summarized in Table 1. This study group tallied 8000+ dive days.

Table 1: Subject Characteristics (mean±SD with range)

	All	Symptomatic	Asymptomatic
Number of Respondents (%)	136	71	65
Age (y)	32±9 (14-55)	33±8 (20-55)	32±9 (14-46)
Gender (% male)	97		
Freediving Experience (y)	14±9.5 (1-45)	15±10 (1-45)	12±9 (1-40)
Freediving per Month (days)	6±4 (1-25)	6.1±3.9 (1-20)	6.1±4.1 (1-25)
Depth of Dives (ft)	32±13 (10-60)	35±13 (12-60)	29±13 (10-60)
Depth of Dives (m)	9.8±4 (3-28)	11±4 (3-28)	8.8±4 (3-28)
Dive Time (min:s)	1:30±0:29 (0:30-3:00)	1:39±0:35 (0:45-3:00)	1:19±0:24 (0:30-2:00)
Knowledgeable of SWB (%)	95	100	89
Hyperventilated Before Every Dive (%)	23	23	23

Seventy-one of 136 respondents (52%) experienced symptoms of severe lightheadedness, near unconsciousness (63 respondents), or unconsciousness (8 respondents) during a dive. This was experienced ranged from 1 to 20 times (median=1) over the entire span of the individual diving career. Seventy-one percent indicated that they were deeper than their average dive depth when an incident occurred, 45% were at their average depth; 65% reported exceeding their average dive time on an incident dive and 32% were at their average time. Twenty-nine percent acknowledged they had hyperventilated prior to an incident dive. Only five were involved in competition at the time of incident. All were knowledgeable of SWB. In the eight divers who experienced unconsciousness (11% of symptomatic divers), two were involved in competition, three indicated they were at their average depth, five had exceeded their average depth, six had exceeded their average dive times, and only one had hyperventilated prior to an incident dive.

There were no statistically significant differences between the symptomatic and asymptomatic subgroups in average age ($p>0.10$), or average days of diving/month ($p>0.10$), average number of years diving ($p>0.10$), or in the proportion of hyperventilators ($p>0.10$). However, there were significant differences in the average dive depths ($p=0.05$) and average dive times ($p<0.01$).

Discussion

This self-reported study is limited by its dependence upon the veracity and accuracy of the recollections of each respondent. Those surveyed in this study are known to be some of the more serious and seasoned freedivers in Hawaii and thus we assumed their reliability.

Conservatively estimating that on each dive day, every diver made 10-20 subsurface excursions, anywhere from 80,000 to 160,000 risk exposures may have occurred. Given the paucity of events acknowledged, the incidence of SWB would appear to be very low. It is intuitive that deeper dives and longer dive times would result in increased risk for SWB and the data in this study supports that notion. Surprisingly, hyperventilation which has historically been implicated as a progenitor for SWB, did not appear to play a significant role in the manifestation of symptoms in this group. Indeed, nearly a quarter of the asymptomatic divers routinely hyperventilated without adverse consequence, and there were no statistical differences between those who hyperventilated and developed symptoms and those that did not. Hyperventilation was a factor in only one of the eight who experienced unconsciousness.

Conclusion

In this study group, diving to depths in excess of 29 fsw (9 m), or dive times greater than 1:19 min:s presented increased risk for SWB. Occurrence of SWB was rare. Hyperventilation was not a significant contributor to adverse outcomes, and thus the historically accepted role of hyperventilation in SWB is unclear. Efforts to reduce risk potential for SWB should be aimed at limiting dive depths and times.

References

1. Craig AB Jr. Underwater swimming and loss of consciousness. JAMA 1961; 176:255-258.
2. Craig AB Jr. Causes of loss of consciousness during underwater swimming. J Appl Physiol 1961; 16:583-586.

WORKSHOP DISCUSSION

DR. BUTLER: Did you have a report on the number of fatalities each year breath-hold diving in Hawaii.

DR. SMERZ: I do not have an exact number for that.

DR. BUTLER: There is an obvious self selection for that in your data. But, you know, it is interesting that all of these reports, everybody's data are anecdotal and there is no central repository of how many people are killed doing this.

DR. SMERZ: I think that is one thing that points out the importance of the database that DAN is trying to create here, to capture some of that harder information in order for us to be able to formulate some sense of interventive techniques. I look at it from the point of advising the divers how to stay out of trouble. An ounce of prevention is worth a pound of cure in this case. That would be a very useful project to undertake.

One thing I might add, with the divers that reported shallow water blackout, there were two divers that specifically pointed out that they had had four episodes of frank unconsciousness and one with five. So it does repeat itself from time to time in those people. And I do not know whether they were the competitors or not. Only one was a competitor.

DR. BUTLER: It was striking that in your analysis of the data, that the warning about do not hyperventilate, just as many people had loss of consciousness without hyperventilating as with.

DR. SMERZ: Right. That is why we drew the conclusion that it is unclear just what the role might be. It is not saying that people should not be cautioned against hyperventilating, but I am not certain that that is the sole reason why they have a problem.

DR. LINDHOLM: I would just like to comment on that hyperventilation is very interesting. I made a review of competitions, performance during breath-hold competitions over the years that is reported on the Internet. I got about 600 static performances and 600 constant weight performances. On the average 10% of static performances ended up in what we call loss of motor control, a little bit of that. Almost one percent had a blackout, or loss of consciousness, on the static. In the constant weight it was five or six percent in each group. But all of these divers, at least all competitive breath-hold divers I have seen, hyperventilate. So it is interesting in terms of your observation too that you say that hyperventilation is not a good predictor whether people pass out or not.

DR. SMERZ: We were surprised because I actually expected to see a higher rate of hyperventilators in the affected group.

DR. BUTLER: There is a conventional wisdom that says that if you do not hyperventilate, you can not hold your breath into a hypoxic loss of consciousness. And what you have just presented does not support that very well.

DR. MUTH: I think it is a question of what I call hyperventilation. If you ask the divers do you hyperventilate, they say no. But if you look at them when they prepare for the dive, they just relax and take a few deep breaths, and many would say they hyperventilated.

DR. SMERZ: That could very well be a problem insofar as at the time the survey was administered there was no specific instruction as to what that was. I left that up to them to tell me whether they did or not based upon their interpretation of that word. I think most of them, based on my experience, understand what hyperventilation is. They know that it is a little more hefty free breathing.

A PROPOSED 60 SECOND LIMIT FOR BREATH-HOLD DIVING

CAPT Frank K. Butler, MC, USN

Command Surgeon
United States Special Operations Command
MacDill AFB, FL, USA

PRESENTATION

DR. BUTLER: I need to start with a disclaimer. I am not going to talk about how breath-hold diving is done in the U.S. Navy. Although I hope that the Navy will eventually adopt this approach to breath-hold diving, it is currently just a proposal.

As we talk about freedivers, we sometimes make them out to be a homogenous group. They are emphatically not a homogenous group. The main purpose of spearfishing while freediving is to hunt and gather, but there is also a competitive element. Long breath-hold times are a badge of honor. These divers take pride in being the person who can hold their breath the longest.

Contrasting this are the commercial freedivers, primarily the Korean and the Japanese Amas. These women have been freediving for centuries. This is not a recreational activity for them. It is a way of life, and they have a drastically different approach to it, as we will see.

Next we have military combat swimmers. Back in World War II, when you did not want the allied countries to invade your territory, what you would do is to place lots of obstacles, often large concrete blocks with spikes sticking out from the top, on your beaches. Beach obstacles and landing craft full of soldiers or Marines do not mix, so a way had to be developed to clear the beaches for landings. A whole new discipline was therefore born in the Navy, the frogman. It was their job to go in attach explosives to these obstacles before the amphibious landings so that the landing craft could reach shore safely. It is been a while since we have done any large-scale amphibious landings, but Navy SEALs still train for this mission.

The next group to consider is the elite breath-hold divers. These individuals are the world's best freedivers, the ones who set records for dive depth and duration.

Finally, we have the rest of us, the non-elite freedivers who are just down there to have fun and to experience the underwater environment in a different way. As we consider the science and the sport of freediving, we need to consider each of these communities somewhat differently.

There are several disadvantages of breath-hold diving. The first is air hunger, something experienced by most breath-hold divers on most dives. Air hunger can detract from the enjoyment of the freediving experience.

Less commonly, but more dangerously, is the risk of hypoxic loss of consciousness on a breath-hold dive. A brief review of the safety of breath-hold diving in recent years will show the magnitude of this problem.

Consider for a moment how the diving medical community approaches safe no-decompression limits for scuba diving. Much research effort goes into defining the safe no-decompression limits for divers and the published limits are quite conservative when compared to the results of research. For example, no-decompression research exposures at 60 fsw [18 m] produced no incidents of decompression sickness in 29 exposures of 66 min bottom time duration. Despite this fact, there are no dive computers that I am aware of that allow a 60 fsw no-decompression dive of 66 min. Generally, diving physicians and scientists have been very conservative about recommendations that they make for decompression, choosing to favor diver safety over maximized bottom time. This philosophy has carried over into the dive instruction industry.

In contrast, what does the diving medical community say about the maximum length of time that you can safely hold your breath on a dive? Not much. Part of the reason for that is the basic premise of breath-hold diving: *Either your body or your freediving experience will tell you when you should end your dive and come up and take a breath.*

So, how well is this premise working? I am going to present a selection of case reports that come from my experience, from the experiences of diving medicine colleagues, or from published media articles.

An experienced, 25-year-old freediver died in 2003 performing breath-hold diving in Ginnie Springs, FL. An experienced 32-year old freediver died recently while doing breath-hold dives in the Cayman Islands. The 31-year-old son of a champion freediver died practicing breath-holding in chest-deep water in a swimming pool. Drs. Edmonds and Walker reported 12 deaths in breath-hold divers in Australia between 1987 and 1996. Two more died in Queensland in December, 2002 and January, 2003.

A 22-year-old University of Georgia student died in June 2001 performing breath-hold dives, again in Ginnie Springs, FL. A world-class woman freediver died attempting a deep breath-hold dive in the Dominican Republic in October, 2002.

A 19-year old college triathlete and lifeguard died in the swimming pool at the University of North Carolina while breath-hold diving. A member of the Mexican national water polo team died practicing breath-hold diving in a swimming pool. Martin County, FL banned breath-hold diving in public pools because of a death there.

The list continues. The excellent work that Dr. Pollock and his colleagues at DAN have done gathering information on breath-hold dive fatalities has produced at least eight more deaths that can be attributed to breath-hold diving.

These reports are troubling, but maybe the military breath-hold divers are doing better. Or maybe not. The next individual, as described in a 1997 case report was an instructor at the SEAL training command. There is a 60 ft [18 m] training tower there that they use to teach the students free and buoyant ascents. This instructor was an excellent breath-hold diver and it was his practice to freedive down to the bottom of the pool, sit down, fold his arms, and watch the students as they did their free ascents. On the dive in question, the other instructors on the surface noticed that he had been down for a long time and appeared to be slumped over. We do not really know exactly how long he held his breath, but he was in cardiopulmonary arrest when they got him to the surface. CPR was done and he was intubated. He was revived on the scene, but went on to die the next day at the hospital in Coronado, CA.

Next is an individual who was practicing breath-hold diving in preparation for SEAL training. He was in the pool in Camp Pendleton, CA when he died. He was a bodyguard for the US Marine Corps commandant, which means that he was an outstanding Marine - lost to breath-hold diving.

The next case occurred in a SEAL student in August, 2001. He was doing underwater knot tying, in which the students go down and tie knots that they will use in preparing explosive charges to blow up beach obstacles. He gave the instructor an "OK" and started to swim for the surface, but as he came up, he lost consciousness while still in the water. He went on to have an anoxic seizure and develop cardiac arrest at the surface. He was resuscitated but had some residual cognitive deficits that precluded him from remaining in SEAL training.

A Navy Experimental Diving Unit [Panama City, FL] diver, a very experienced diver, drowned while free diving in a Florida spring. A Naval Academy midshipman, practicing breath-hold diving in preparation for SEAL training, died in the pool at the Academy. Another SEAL was treated at the Naval Hospital in Pensacola, FL, having suffered permanent neurological residual from a breath-hold dive incident in a pool. Yet another SEAL lost consciousness during a breath-hold dive and was in the intensive care unit for a week with adult respiratory distress syndrome (ARDS).

So, overall, is this an acceptable safety record?

Well, it is difficult to say. The problem is that we do not have the denominator data. In addition, all of the details of the events are not known. Alcohol may have been a factor in some of the fatality reports. Medical issues could also have caused loss of consciousness as well, although the cases we have discussed here involved mostly young, fit divers.

As a general statement, however, when talking about recreational diving or military training, I think there should be little or no tolerance for breath-hold dive fatalities.

If we were going to try to make breath-hold diving safer, where would we start? Let me start with a question. How long can an individual hold his or her breath before becoming unconscious?

CAPT David Southerland of the Navy Dive School is fond of saying that most questions in medicine can be answered with two words: "It depends."

That is definitely the case with this question. How long a diver can hold his or her breath underwater depends. Is the diver in air or immersed? Resting or exercising? Breathing air or oxygen before the breath-hold? From a family of elite breath-hold divers? Following a specific training regimen? What training regimen? Are techniques like hyperventilation or lung packing being used?

Breath-hold duration is frequently based on resting, or armchair, performance. Figure 1 depicts the arterial oxygen saturation measured with pulse oximetry (S_pO_2) as a function of breath-hold time in a single, non-elite, male breath-hold diver (unpublished data). The individual hyperventilated on room air for 30 s prior to breath-hold. The subject remained at rest during one breath-hold, and pedaled a cycle ergometer at a rate to consume approximately $400 \text{ kcal}\cdot\text{h}^{-1}$ during the other.

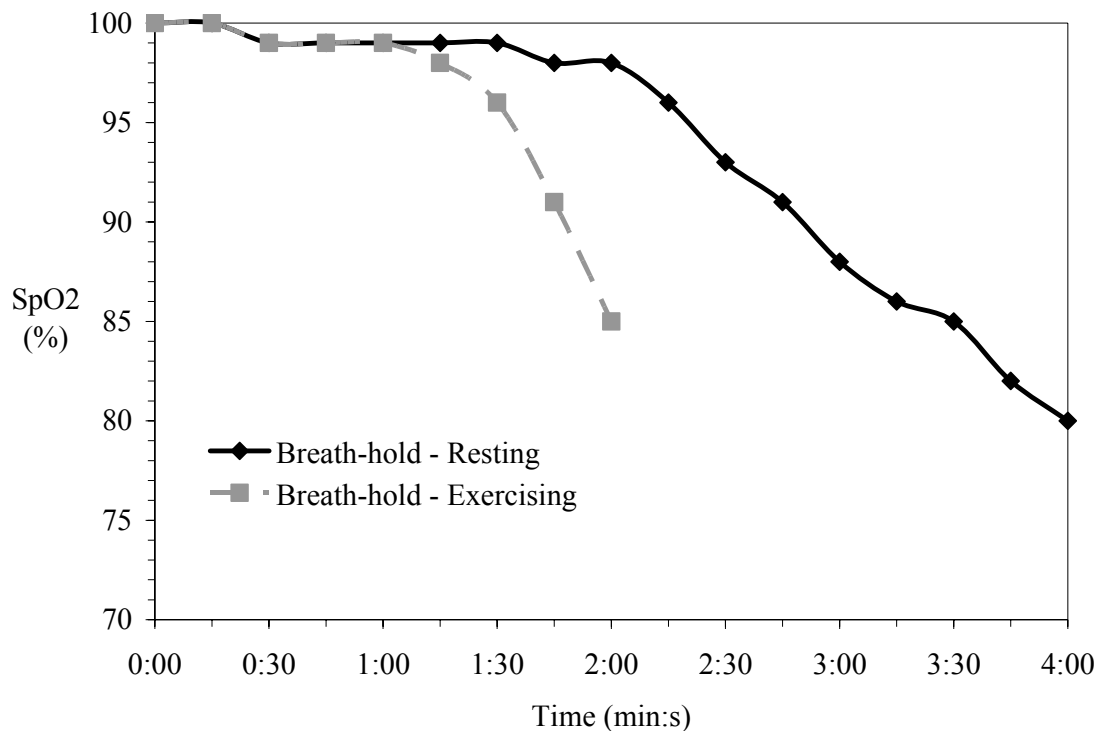

Figure 1: Arterial oxygen saturation and breath-hold duration during resting and exercising breath-hold (unpublished data)

Oxygen saturation remains quite stable the baseline value of 98-100% for the first 1:30 min:s in both cases. It begins to drop after that much more sharply for the exercising case. The breath-hold duration is cut in half with exercise, from four minutes to two minutes. Increasing the oxygen consumption, not surprisingly, decreases breath-hold time and results in more rapid oxygen desaturation. The S_pO_2 at breath-hold breakpoint was 80% during rest and 85% with exercise.

A more dramatic example is seen in the information provided on Tanya Streeter's website. In August, 2002, on her 525 ft (160 m) No Limits record dive, during which she rode a weighted sled down and a buoyant bag up, her breath-hold time was 3:26 min:s. In July, 2003, on her Constant Weight Without Fins record dive, which entails more exercise, the dive depth was shallower (115 ft [35 m]) and the breath-hold time was shorter by about half (1:44 min:s). Here again, exercise cut breath-hold time approximately in half.

With this understanding, let us go back and restate our question more precisely. How long can an *exercising, immersed* diver hold his or her breath without losing consciousness?

The published literature provides insights on this question. Many studies have been done on the Ama breath-hold divers. Stanek et al. (1) studied four AMA divers, and found that in 92 routine dives lasting from 0:15 to 0:44 min:s, arterial saturation did not drop from pre-dive values of 98%. It is interesting that these Ama divers do not routinely attempt heroic breath-hold times. This is their living. They are going to be breath-hold diving their entire lives, and want to do it safely.

When Stanek et al. (1) asked the Ama divers to hold their breath for as long as possible, they found that in 15 dives, the average breath-hold time was only 1:09 min:s, but the mean arterial saturation had dropped to 73%. Remember that once the oxygen saturation begins to fall, it does so rapidly. The authors concluded that "...it seemed that at least 60 s of breath-hold preceded the onset of desaturation of arterial blood in these divers."

A quote from Drs. Lundgren and Ferrigno (2) in 1999: "The professional breath-hold divers of Japan and Korea have an excellent safety record as they limit their dives to not much longer than one minute to avoid hypoxia."

Dr. Wong (3) published a study of pearl divers in the Tuamato Archipelago, near Tahiti in 1999. It is the practice of these divers to hyperventilate for three to 10 min before beginning their breath-hold dives. They also typically make a weighted descent, which reduces the amount of exertion needed for descent. They averaged 1:30 min:s on their freedives in this series, with an impressive maximum time of 2:35 min:s. Less impressive is their safety record, with five episodes of hypoxic loss of consciousness in one six-hour workday among the 235 working divers. One of these episodes resulted in a fatality.

Drs. Lanphier and Rahn (4) from Buffalo published a breath-hold study in 1963. They looked at seven exposures of 60 s with immersed and working divers and had no loss of consciousness. They then did six exposures at 80 s. There were again no episodes of loss of consciousness on these dives, but two of the six divers had symptoms of hypoxia at the end of the dive. So, going out to 80 s on an immersed exercising dive, at least in this study, gave us a 33% incidence of symptomatic hypoxia, with a lowest P_aO_2 of 24 mm Hg and a lowest arterial saturation of 58%.

Drs. Pollock and Vann (5) from Duke reported a study in 2000 that was funded by the U.S. Special Operations Command. Seven divers performed immersed, exercising breath-hold dives after hyperventilation and had a mean breath-hold time of 1:26 min:s. There were no episodes of hypoxic loss of consciousness in these seven dives. When discussing the topic of safe limits for breath-hold dives, they proposed a two minute limit at rest and a one minute limit for exercising divers.

Dr. Qvist et al. (6) in 1993 studied arterial blood gases during immersed, exercising dives performed by five Korean Ama divers. Once again, these divers did not seek to achieve maximal breath-hold times, with their average dive being approximately 0:30 min:s. The investigators then requested that the divers hold their breath as long as possible for a series of 37 dives. The mean breath-hold time on these dives was found to be 1:02 min:s with a maximum time of 1:24 min:s. The P_aO_2 after this longest dive was 33 mm Hg and the arterial oxygen saturation was 59%. The authors stated in conclusion: "In the current study, dives that lasted longer than 55 s were associated with large and potentially dangerous decreases of arterial oxygen pressure and content."

An article from Alert Diver in 2005 (7) noted that: "We really do not have a definitive study on the issue of a safe breath-hold limit for exercising free divers but the number best supported by the data at this time is 60 s."

A recent chapter on military diving (8) stated: "The practice of immersed, exercising divers holding their breath in excess of 60 s should be re-evaluated." In the interest of full disclosure, I authored the Alert Diver article and co-authored the Bove chapter.

Let us finish up with four proposals for your consideration. Proposal One is that the diving medical community establish 60 s as a maximum recommended breath-hold time for non-competitive breath-hold diving.

I know that two groups are not going to be big fans of this idea: breath-hold spearfishers and elite, competitive breath-hold divers. I certainly do not have the expertise to presume to make any recommendations for a group of world-class athletes like these two communities, but let us acknowledge that these divers are just that. They are on the cutting edge of their sport, attempting heroic breath-hold times, and are responsible for establishing their own limits and their own safety techniques. They also are willing to accept a greater level of risk than we would for recreational diving or military operations.

I compare them to elite mountaineers who attempt the summit of Everest. Historically, the average mortality on summit attempts has been around 10%. There were just over 100 climbers in base camp at Everest in 1989. Eleven of them were killed. So these are people who do extraordinary things, and accept extraordinary risks to do them.

Non-elite divers do not need to take similar risks just to go out and look at the reef creatures.

Proposal Two, assuming that we are going to terminate our breath-hold dives at 60 s, is to allow 30 s of hyperventilation. There is no evidence to suggest that you increase your risk of hypoxic loss of consciousness by hyperventilation – as long as you end your dive at 60 s. This also makes the dive much more comfortable. It is a totally different experience to go down and stay for 60 s without air hunger. Additionally, it allows you to have better task focus, whether that task is a military one or personal one.

Proposal Three is to better define the maximal safe breath-hold time for immersed, exercising divers in the laboratory setting. A study at Buffalo or Duke could standardize the oxygen consumption in a group of divers to the appropriate level for underwater swimming, monitor oxygen saturation during the exposure, and determine if the divers can safely go for longer durations. One of the issues that we would have to come to grips with is: "How safe is safe enough?" If you perform 50 exposures breath-holding to 90 s and have two losses of consciousness, is that safe enough? That question would have to be answered prior to doing the study.

Proposal Four is that we do a better job of collecting data from breath-hold dive events, competitions, and accidents and analyze this data appropriately. The researchers at DAN have made a very strong start on this. More data on this topic from non-controlled breath-hold diving events and accidents would allow us to get a more precise risk analysis and a better definition of a safe breath-hold limit for immersed, exercising divers.

References

1. Stanek KS, Guyton GP, Hurford WE, Park YS, Ahn DW, Qvist J, Falke KJ, Hong SK, Kobayashi K, Kobayashi H, et al. Continuous pulse oximetry in the breath-hold diving women of Korea and Japan. *Undersea Hyperb Med* 1993; 20(4): 297-307.
2. Ferrigno M, Lundgren C. Human breath-hold diving. In: Lundgren CEG, Miller JN, eds. *The Lung at Depth*. New York, Marcel Dekker, 1999.
3. Wong RM. Taravana revisited: decompression sickness after breath-hold diving. *SPUMS* 1999; 29(3): 126-131.
4. Lanphier Eh, Rahn H. Alveolar gas exchange during breath-hold diving. *J Appl Physiol* 1963; 18(3): 471-477.

5. Vann RD, Pollock NW, Natoli MJ, Corkey WB: Oxygen-enhanced breath-hold diving. Center for Hyperbaric Medicine and Environmental Physiology Report. Durham; Duke University Medical Center; 24 March 2000.
6. Qvist J, Hurford WE, Park YS, Radermacher P, Falke KJ, Ahn DW, Guyton GP, Stanek KS, Hong SK, Weber RF, et al. Arterial blood gas tensions during breath-hold diving in the Korean Ama. *J Appl Physiol* 1993; 75(1): 285-293.
7. Butler FK: Breath-hold diving: a proposed 60-second rule. *Alert Diver* 2004; September/October: 35-39.
8. Butler FK, Smith DJ. United States Navy Diving Techniques and Equipment. In: Bove AA, ed. *Diving Medicine*, fourth ed. W.B. Saunders: Philadelphia, 2004: 547-574.

WORKSHOP DISCUSSION

DR. FOTHERGILL: You did not mention one population, and that was the U.S. Navy diving population. How do you speculate if you put in the proposal of the 60-second breath-hold limit would impact extended training procedures in dive school and SEAL training?

DR. BUTLER: This proposal has actually been made, but not implemented to date. I would like to say that we have not lost the battle. We have just not won it yet.

DR. SCHAGATAY: I wonder why focus on time, because for one thing we know that all these various individuals are untrained. I think that the recommendation of time would focus on the wrong thing because what you have to learn to focus on are your body signals. To have a recommendation that everyone surfaces at the first involuntary contraction would be much more useful system for most divers, for the ones with the short breath-holding ability during exercise and for the ones with a good natural ability. So I do not see what purpose it would be to have a recommendation of 30 s or 60 s or three minutes at all actually.

DR. BUTLER: If we established a limit based on the first involuntary contraction, what time would that give us?

DR. SCHAGATAY: Does not matter, because the interesting thing is to limit the risk.

DR. BUTLER: I do not know. That could be unnecessarily restrictive, but it is an interesting counterproposal.

DR. SCHAGATAY: It would be an average of maybe 60 s anyway, but I think in itself the recommendation should focus on the individual ability to make it a good system.

DR. BUTLER: Right. Well, I do not necessarily disagree with that – it is an interesting physiologic alarm clock. However, I do not think it is the practice of any breath-hold dive communities that I know of to do that. The idea is typically to hold your breath through that symptom.

DR. SCHAGATAY: I am training children with free diving, and we have also in the very young kids we can see some kids that can breath-hold for 15 s and some who can easily do three minutes. I also

measured the saturation in some of them just to see what they are doing, and they have a very different situation. I mean, they – if they learn how to recognize the signals, they will surface in time.

DR. BUTLER: It would be interesting to compare the two and see what they each give us for limits. I just have no feel for exactly what sort of limit that would give us and how safe it would be.

DR. LUNDGREN: If I could make a very brief remark from here. We heard of some, and I certainly have no feeling for how many it would involve, who really do not feel anything.

DR. BUTLER: Yes. Certainly there are a few of those out there. If I do not hyperventilate, I start to get that urge to breathe fairly early on. We would have to define whether or not we allowed the divers to hyperventilate before the dive.

DR. SCHAGATAY: It only works when you do not have them hyperventilate first.

DR. BUTLER: Well, if you did not hyperventilate, my guess is that you would get a safer but a more restrictive limit. But, again, I have not seen data to describe the time to onset of that particular symptom in a study.

DR. YOUNGBLOOD: Thanks, first of all, for an excellent and provocative presentation. I would like to point out one thing, unlikely though it might be, in the support for limited hyperventilation. That is it gives you a cushion if you should be so unlikely as to get entangled in a fishing line or have a boat come roaring up overhead and need some extra time, just as long as you do not use it up for things that you should not.

DR. BUTLER. Thank you for that point.

DR. SMITH: It would seem to me that we could certainly do more preventive and diagnostic work on people that are interested in doing this, and maybe that is something DAN is already doing. If not, they could look into it. People would pay to have it done. I mean, basically, everything from a stress test to heart rate variability testing.

We had a University of Florida freshman football player who is the star of the team fall over dead in practice. We read about it everyday in the paper. Obviously, some of the injuries could be related to that as a function of low oxygen saturation, a little more acidosis in the heart triggering arrhythmia. So if we really knew beforehand – I mean, I can see the future being, it would be just like pilots. A pilot they do it because they have got somebody else usually in the plane with them. But for the divers to have an annual, just look at your blood work, blood pressure, and general indices indicating what condition you are in. And one of the neatest things out there now is heart rate variability as a diagnostic indicator of whether you are really at your best on a given day or not. I could see a time when people would actually determine that, and if your baseline is at a certain level on a given day, you are 20 or 30% less, it is a real wakeup call.

I agree with Dr. Schagatay, it is so individual. To expect somebody like some of the people sitting back here to go down for one minute is not at all realistic. And yet there are a lot of people, and I see them all the time, free diving in spearfishing are really asking for trouble at two and a half and three minutes and what not.

DR. BUTLER: To reiterate, there is no presumption of making any recommendations for the elite, world class breath-hold diver. This is for a recreational freediver or an individual who shows up at SEAL training with little or no experience in breath-hold diving.

In my research, I really did not find anybody who became hypoxic in 60 s, but it all depends on your oxygen consumption. If you have an individual who is really flailing around on the bottom, I am not one hundred percent sure that you could not have a hypoxic loss of consciousness in less than 60 s. I have just never heard or read of it happening.

DR. SMITH: A huge factor in the spearfishing community is even take a one or two-knot current in the water when you are used to doing a 40-50 ft [12-15 m] dive looking for grouper when it is at slack tide, just having to swim upstream and then having to go down and you put that extra effort, that is a real problem. I can see one thing in the future would be very interesting. I would think we could create a waterproof oxygen saturation monitor that you could put over the carotid artery that could feed back the vibratory signal that as the vibration became stronger you would realize that my sat has gone from 98 to 88% and now it is down to 80% and I better be getting to the top real soon.

DR. BUTLER: I think that is a very interesting proposal. Other people have proposed variations of that. If the Navy or the military community acknowledged that there was a problem in this area, it would be not technologically hard to do.

DR. VANN: What you are asking for is essentially population statistics. And that is the kind of information you need before you get into this – not scientific information. You need that before you get into the more political questions about what is safety. I think what you propose is not really inconsistent at all with what Dr. Schagatay was saying because you are going to get that same information on the first contraction from your study. So you are going to get them both. And you can play either way.

Remember, there is a difference between doing the science and then making safe decisions. That should be done in totally different context. And mixing them up is just asking for trouble.

DR. BUTLER: I agree with that premise, but if you look back at the research that is been done on breath-hold diving, most of it has not been focused on the issue of how long a diver can hold his or her breath before they become unconscious. Most of the studies on breath-hold duration focus on the effect of various factors such as training and water temperature on breath-hold break time. As you train, you increase your breath-hold duration, but there is no evidence that I can find that says that (in the absence of perhaps some specific things like lung packing) training increases the time required for the diver to suffer a hypoxic loss of consciousness.

So - another way of looking at training is that as you get to be a better and better breath-hold diver, you are getting closer and closer to the point where the lights go out. I think that that is something that has to be included in the discussion as well.

If you were going to make a judgment evaluation of how safe is safe enough, that is a topic that I am sure that we could talk about for a long time. A single episode of hypoxic loss of consciousness could represent a fatality in an unmonitored situation.

DR. LINDHOLM: I would like to make a few comments, partly in support of Dr. Butler's idea about the time limit. One, the first is, that you cannot use contractions the same, because if you are diving at depth, if you get contractions and you start to surface, it is a big difference if you are at the surface or if you are at 30 m (100 ft), or if you are at 100 m (300 ft). So using the urge to breathe as a signal is probably not a good idea.

Another study on hyperventilation was done by P.G. Landsberg about 30 years ago, and his final recommendation was to have the spearfishermen or sports divers of South Africa to use a watch with an alarm clock.

[Landsberg PG. Hyperventilation: an unpredictable danger to the sports diver. In: Lundgren CEG, Ferrigno M, eds. Physiology of Breath-hold Diving. Undersea Hyperbaric Medical Society: Bethesda, MD, 1987: 256-267.]

I would also agree with Dr. Vann that the problem is that we do not have any population data. There has yet been no study where you look at exercise, different work loads, and you correlate with lung volumes and look at bigger material. There has been a few studies with up to maybe 20 subjects, but there are no real good population studies. So what duration that would be appropriate (60 s?, 75 s?), that is another concern.

And finally, I would also like to say that if you hyperventilate, you increase the oxygen stores, as was mentioned here, so you have a bigger margin, but you probably also reduce your oxygen consumption, because you are very much more relaxed. In fact, those contractions can, at least for me, they cause a little effort. It is painful. If you completely relax, you reduce your oxygen consumption. So you probably, if you hyperventilate, you actually push the duration forward even more. Not to say that hyperventilation is safe, but it is a good point to have that you might need to reevaluate how we perform the safe training dives.

DR. BUTLER: Thank you.

MR. KRACK: I certainly appreciate the presentation, where you are coming from with it. I guess I worry about things that are perceived as rules that would make things to be safe or the perception of safe when if, for example, even in hyperventilating for 30 s it is possible to experience a blackout. When we put in rules that would say 60 s, one minute breath holds. But that mitigates the idea of really the overall problem that I would say most of those facilities being without lack of, and I will always go back to this, direct supervision, buddy contact. If I do not dive with a buddy but I maintain my dives within the one minute rule, I am safe. I think we always have to come back to the idea that buddy contact and direct supervision is the key to it.

A one minute breath hold could be a relaxed 30 m [98 ft] down and 30 m back up in a typical dive profile. Persons trying to better their depth are going to increase their speed, which would work against them at that point. So I can understand the pros to the ideas, but there would certainly be a lot of cons to it that need to be addressed.

DR. BUTLER: I appreciate your point. That is why I took some pains to exclude the elite breath-hold divers from the proposals.

MR. KRACK: I would not say that 100 ft [30 m] indicates an extreme breath-hold diver. That is becoming a very common recreational freedive nowadays.

DR. BUTLER: I am not trying to include a depth consideration in this discussion. It really is more about time and oxygen consumption. Some of the techniques used by elite breath-hold divers, such as riding a sled down and a balloon up, reduce oxygen consumption significantly.

What the studies that I presented had in common was that they looked at exercising, immersed divers. They were engaged in an activity that produced an oxygen consumption that we could then extrapolate to other immersed, exercising divers, however roughly.

One point about the freediving spearfishers, many of whom are also elite breath-hold divers, is that when they are stalking, that may also have the effect of minimizing oxygen consumption as well. They drop down to a reef and wait for the fish to come to them. Believe me, the fish can swim faster than you can, so that approach makes a lot of sense. So when you see elite spearfishers with two and a half minute breath-hold times, I think it is a mistake for the average novice freediver to extrapolate that to his situation if he is swimming continuously underwater.

It is all about oxygen consumption and there are lots of factors that can change that, such as cold water versus warm water. There was a study in Buffalo that looked at the increase in oxygen consumption just from being immersed in cold water and it went up by a factor of 250%. How warm the water is where you are diving can make a huge difference in your oxygen consumption and how long you can hold your breath safely.

SHALLOW WATER BLACKOUT: THE PROBLEM AND A POTENTIAL SOLUTION

Terry L. Maas, DDS, MBA

¹ Diplomat of the American Board of Oral and Maxillofacial Surgery

² Fellow of the American Dental Society of Anesthesiology

³ Chair IBSRC, Underwater Society of America

Introduction

In contrast to elite freedivers who pursue depth and duration records in very safety-controlled environments, recreational freedivers, representing over 95% of freedivers, do not dive in a safety-orientated environment. Recreational freedivers die at an alarming and predictable rate due to the consequences of loss of consciousness (blackout).

Patterns of Freediving Blackout

Freediver blackout can be divided into three types depending on the circumstances and physiology surrounding each (Figure 1).

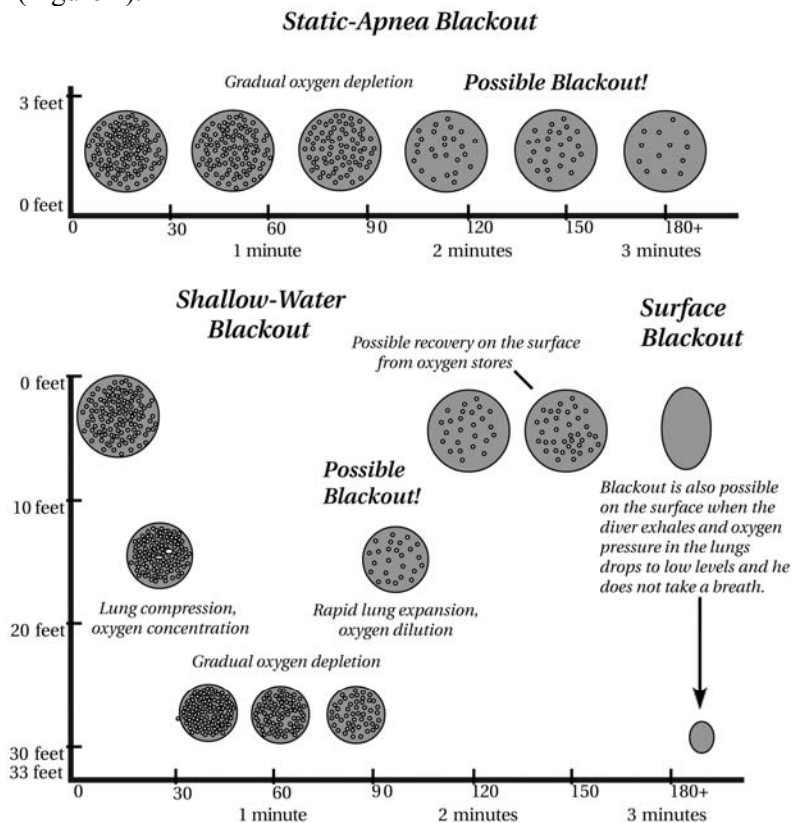

Figure 1: Illustration combining the concepts of static-apnea blackout, shallow-water blackout and surface blackout (Adapted from 1).

Static-Apnea Blackout: Here the freediver dives to the bottom of a pool or body of water and blacks out without ever attempting to return to the surface, or while resting on the surface of the water in face-down position. These divers black out from simple lack of oxygen without the pressure-compounding problems ascending divers experience.

Shallow-Water Blackout (SWB): SWB occurs when the ascending diver's blood-oxygen levels are low and when the expanding lungs, instead of forcing oxygen into the blood as they do during descent, expand and draw precious oxygen back from the blood – "the vacuum effect." Blackout often happens before reaching the surface.

Surface Blackout: This occurs when the diver exhales on the surface. As long as the diver holds his breath, there is some oxygen pressure available to the blood. On the surface, the hypoxic diver exhales. Almost immediately, there is a decrease in oxygen pressure, which further compromises oxygen available to the brain. Exhalation places the hypoxic freediver in potential jeopardy for two reasons: **1) Oxygen pressure drops:** This sudden drop in oxygen pressure in the lungs can precipitate instant blackout when he is most vulnerable – before he has taken a breath. When the diver passes out on the surface and has taken in little or no air, he may be negatively buoyant and begin to sink. As the diver sinks, the hydrostatic pressure pushes out what little remaining air is in his lungs and the diver sinks rapidly. We have witnessed this phenomenon in one individual and confirmed a similar scenario from another victim's dive computer downloaded profile (Figure 2). **2) Thoracic pressure drops:** At exhalation the pressure in the thoracic cavity decreases dramatically. When the large veins that feed the heart lose some of their support because of the sudden decrease in chest pressure, they are not able to feed the heart as effectively and therefore 'preload' to the heart pump is decreased. During this period, cardiac output may decrease and consequently, blood flow to the brain is further compromised.

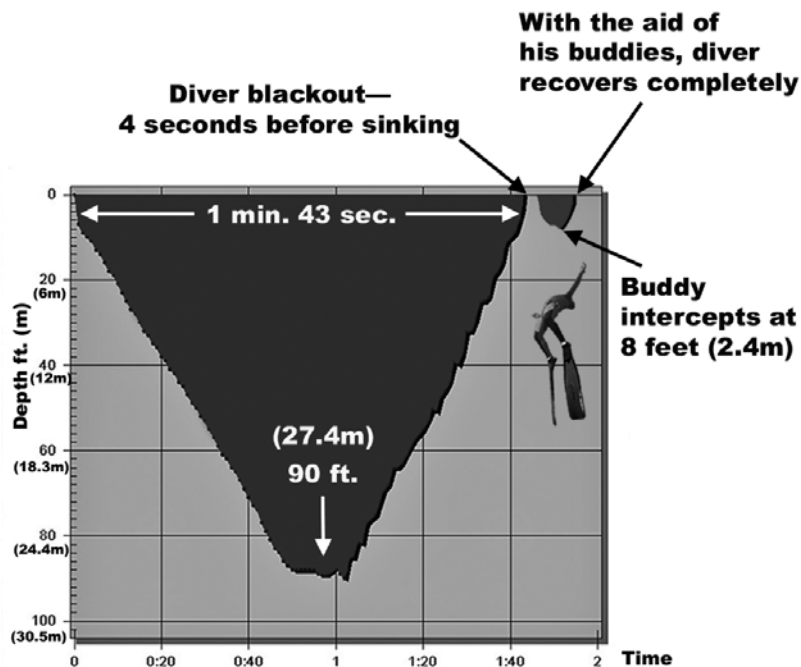

Figure: Computer-generated dive profile of a freediver experiencing surface blackout after a breath-hold dive.

We also hypothesize that oxygen deprivation (hypoxia) and/or carbon dioxide elevation (hypercapnia) lead to irrational and distorted thinking – most acute in the last 30 s of the dive. Why else are victims of freediving blackout routinely found on the bottom with their weight belts firmly in place – their one last potentially life saving effort ignored?

Carbon dioxide levels also have profound effects on the diver's ability to hold his breath and can be as important as oxygen levels. Blowing off carbon dioxide causes respiratory alkalosis, which increases the breakpoint, and can cause mild dizziness and muscle cramps. On the other hand, breath-holding and muscular exertion increases blood carbon dioxide levels, which can cause acidosis. High levels of carbon dioxide will shift the oxyhemoglobin dissociation curve unfavorably, can impair a diver's judgment and is anesthetic (Figure 2). Human physiology changes day-to-day and hour-to-hour.

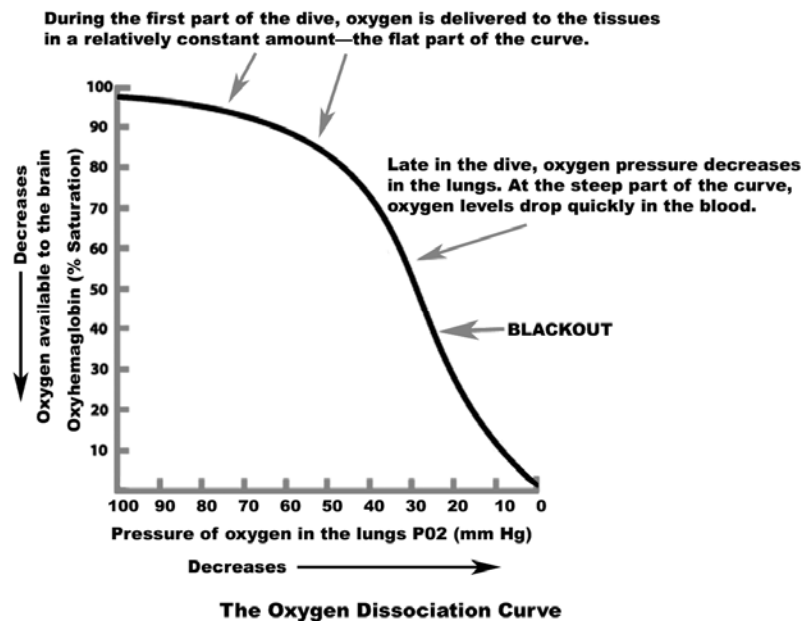

Figure 2: The stylized oxyhemoglobin dissociation curve. The horizontal axis is reversed for presentation.

Recent deaths related to freediver blackout are summarized and a safety solution proposed.

Freediving Fatalities

The author polled well-known recreational freediving enthusiasts in the major English-speaking regions with recreational freediving populations exceeding 10,000. Because no region or country classifies drowning as a result of freediver blackout, regional experts were asked to make their best estimation of freediver blackout-related deaths yearly based on the average for the last decade. Deaths averaged three per 10,000 yearly. In France alone, with its estimated 100,000 active recreational freediving, 33 died in 2003. The rate of deaths corresponds to regional water clarity, with more deaths in clear water.

Table 1 provides a summary of the estimated number of freediving deaths on an annual basis for countries with known active freediving communities.

Table 1: Estimated yearly fatalities due to freediver blackout (based on 10-year averages)

Country	Estimated Number of Freedivers	Estimated Number of Freediving Deaths Annually
United States- Continental	10,000	3
United States- Hawaii	5,000	6
Greece	50,000	6
Australia	15,000	10
Italy	12,500	12
Portugal	3,000	3-5
New Zealand	1,000	2
South Africa	8,500	0-1
France	30,000	8-10 ¹

¹ Thirty-three French freedivers died from SWB in 2003.

Protective Vest

Almost any popular sport with such a clear and present danger has adopted safety equipment to mitigate loss of life and limb. Parachutists use a back-up parachute, cyclists use helmets and drivers use seat belts and shoulder harnesses. While several groups in the past have proposed and designed a safety floatation vest for freedivers, no such equipment exists today. The author facilitated an Internet-based forum for the collaboration of over 50 influential recreational freediving leaders to develop the structure and logic for a safety vest.

Participants reached consensus on the following features for the SWB-protective vest. Users preset two parameters, maximum depth and maximum duration, onto a wrist-mounted unit, which displays the course of the dive and communicates with the streamlined, back-mounted inflation unit. Should the diver encounter a problem, which exceeds either parameter, the vest inflates bringing the diver to the surface face-up.

Conclusion

The deaths from freediving blackout are depressingly constant. Using modern technology coupled with the logic developed above, the manufacture of a recreational freediving safety device is practical, essential and, indeed, inevitable.

Disclaimer

Since this paper was delivered, Dr. Maas has acquired an ownership interest in the company developing a protective freediver safety vest.

Reference

1. Sipperly D, Maas T. *Freedive! BlueWater Freedivers*: Ventura, CA, 1998: 35.

WORKSHOP DISCUSSION

MR. KRACK: When do we get it?

DR. MAAS: Give us your name and we will get you a prototype. A lot of people here will get those to give us feedback. The worst thing you can do is get this out too early and have it screw up.

MS. RIDGWAY: Terry, we were talking about this last night at dinner, and we all thought it was a good idea. And then I remember that, and it probably is in your book that also anecdotally some of the divers have told me and I have seen vision of when they are returning from a deep dive, generally following, and this would not be for spear fishermen necessarily, are returning in quite a strong vertical position. And the moment that they start to black out, it seems that there is this arching of the back. And I just wonder if there could be a trigger mechanism that was posturally based for those divers. I do not know if it is possible, but it was just a post-wine discussion last night.

DR. MAAS: Actually, and that brings the tension between too many features and reliability. It would be nice if a whistle went off, and we could do that. And then dye goes in the water, and we might do that too, to let somebody know, your supervision that is not watching you, that there is this dye around you and you are whistling.

DR. FEINER: Four seconds at the surface is plenty of time to take a breath. And I think even on the film earlier of a static breath-hold, it seemed that the maximum dizziness and the motor loss of control or samba occurred after breath. In doing studies on pulse oximeters where we make subjects hypoxic down to saturations in the 60s and 70s, we have noticed for some time when we give them oxygen coming back, I, myself, have been a subject in the study, you actually get extremely dizzy and the peak euphoria is actually with the first breath of oxygen. Everyone seems to be suggesting some hemodynamic of blood shifting effect, postural effect on surfacing. This would, our experience would suggest that there is probably something to the first breath, either cerebral blood flow from the changes in blood gas, in some instant release the neurotransmitters. It is a repeatable effect just with gas exchange.

DR. MAAS: I believe your right. That is only conjecture on my part what happens there. I absolutely know from the case I observed that the first breath was not taken. It was not taken. Because he was buoyant with a full chest of air. So he exhaled and started the inhalation, and it was not taken. And I think the other one would suggest the same thing. And there is yet another one from South Africa. I will try to get these profiles for you.

One of the problems with reporting is that the families of these folks – the people who recover this material do not want the family to know that their dear one was on the surface. And so this is part of the problem with collecting data is people are reluctant, they hold onto this.

DR. ANDERSSON: I do not know if Peter is going to make the same point as I am here. I would suggest another explanation for the surface blackouts, maybe a more simple one than the preload changes and so on. And that is circulatory delay between the lungs and the brain tissue. Because, of course, there is a circulatory delay with the oxygenated blood reaching the brain. You do not have your lowest oxygen saturation, blood oxygen saturation in the brain until a couple of seconds after you surface, which would, well, fall in line with your divers losing consciousness a couple of seconds after they surface.

DR. MAAS: That is why I am saying I have got a foot in both field. I know enough physiology to be dangerous. The point is that something is happening there that makes a person very vulnerable. That

was my conjecture of what it might be. It certainly delayed – it is just more of the same. You have not reached equilibrium. You can take the breath and it still has not made the 15-second circuit. It is no different from the guy who just sat at the bottom of the pool and lost consciousness. It is still lack of oxygen.

DR. ANDERSSON: And, of course, it could be delayed by diving response, delaying the flow of oxygenated –

DR. MAAS: Absolutely. I should probably develop a list of why. If you want to put a Swan Ganz catheter in somebody, put them in a decompression chair, we could answer some of those questions. That is pretty invasive though.

DR. LINDHOLM: Dr. Andersson made the comment on the delay. I would like to make a comment that there is an observation in altitude medicine that if you have acute altitude hypoxia and then you give them oxygen, which now we are talking fairly high altitudes so the PO₂ of that pure oxygen would be in the range of maybe what it would be if you inhale air at surface level, they saw aggravation of symptoms. They call it oxygen paradox. I do not think it is ever been studied in breath-hold diving. But an interesting observation is that this exhalation and the inhalation, I know from Kirk Krack and his team when I went to train with them in 2000, they have already developed their partial hook breathing technique. Which means when you come up from a breath-hold dive, you exhale a partial breath and then you inhale. That will have two effects. First, you will save time to get oxygen in the lung. But it could also have an effect – now I am very much speculating – that you actually dilute the air that comes in, so you do not get such a steep increase in oxygen. Whether that is physiologically true or not, it is pure speculation at this point, but it is interesting that it seems to work for you guys.

DR. MAAS: That is a valid point. I am aware of that. At still some point your PO₂ goes to zero when you exhale, and it was more than zero before you exhaled.

DR. SMITH: Has anybody done any research on animals or maybe it could be done on humans. But the very fact that your lungs are so contracted even at 66 ft [20 m], forget about 150 ft [46 m] or deeper, that when you hit the surface, depending on your lung stiffness and whatever else, we are really asking a lot for a lung with an alveolar capillary membrane that instantly be completely functional. And that could be a variability based on an individual. You would think maybe that is the big problem right there. It is almost like having acute micro-adult respiratory distress syndrome (ARDS) type event.

DR. MAAS: Maybe. You know, honestly, you could be right. I think you have got pressure expanding your lungs, the alveoli will probably all pop all back out.

DR. SMITH: Even if they are opened, the oxygen exchange, there may be a lag time.

DR. MAAS: Absolutely. There is something lagging.

DR. FOTHERGILL: A comment about the magnitude of loss of consciousness once you hit the surface. You are going to just offload that CO₂ with the first breath and then you are going to get this sudden change in CO₂ within the blood system. And then will probably shut down or vasoconstrict the circulation to the brain, which will then even further reduce your PO₂.

DR. MAAS: Fascinating. Yes. That kind of brings my point. I just should have said, these are two ideas. This is what is so fascinating. The human body has about five thousand mechanisms we know of and another hundred thousand we do not know of. Anecdotally, we know that this happens.

MR. KRACK: I just want to comment, Dr. Maas, that I think this thing is going to save a lot of lives in the spearfishing community. The sooner it is out and tested and proper working, the better it is going to be. Obviously, education has to support it. There is no doubt that this is going to be a good thing and we are right behind you with it.

DR. MAAS: Thank you. And I refer to you too so. I think you are doing a good job with the training. I just wish people were smart enough to take advantage of it.

DR. LUNDGREN: I do not know why I did not think about it earlier, but perhaps it is because the experience or rather the experimentation I wanted to briefly mention goes so far back. So for you who like me are too old to remember or those who are too young to have noticed these studies which we published in the late sixties, and which actually have entered most textbooks on diving physiology, there is a phenomenon that we called alternobaric vertigo, which shows its ugly face sometimes in divers during ascent. And it is exactly what the name says. It is a sometimes very intense swirling sensation, sometimes combined with severe nausea and severe disorientation to the point where you do not know what is up and what is down. Most of those who have vomited underwater we probably do not hear the story from, but those who, after reaching the surface, have been dizzy enough to vomit would certainly have been in a precarious situation had it happened under the water.

[Lundgren CE. Alternobaric vertigo - a diving hazard. Br Med J 1965; 2(5460): 511-513.]

The mechanism behind it is an inequality in the pressure equilibration in the ears during ascent. This is most common in people who have problems with pressure equilibration when they go down. And what happens when you force yourself down is a swelling of the Eustachian tube, which on the next descent and the following descent makes it more and more difficult to pressure equilibrate in one ear.

I am just putting it to you that there is this additional possibility for loss of life in breath-hold diving, perhaps even more so than in scuba diving, which is the material that we studied. The scuba diver has time to go down slowly. He or she has time to stop on the way up, relieving the beginning vertigo, which can be done by going down a few feet again to relieve the pressure in the middle ear, which is disturbing the circulation in the middle ear.

Breath-hold divers do not have that option. First of all, they have a tendency to go down faster, maybe letting one ear lag behind more than the other, and they certainly do not have much time to stop or go down again when on the way up. If somebody just disappears, it is not necessarily hypoxia of ascent.

SAFETY TECHNIQUES AND PROBLEM MANAGEMENT IN RECREATIONAL AND COMPETITIVE FREEDIVING

Kirk Krack¹
Martin Stepanek²
Mandy-Rae Cruickshank¹

Performance Freediving
¹ Vancouver, British Columbia, Canada
² Fort Lauderdale, Florida, USA

PRESENTATION

DR. LINDHOLM: I would like to introduce Kirk Krack, Martin Stepanek and Mandy-Rae Cruickshank of the Performance Freediving team. Those of you who know breath-hold diving know that they are world champions. Mr. Krack is their coach and team leader. They have also been teaching clinics all over the US and Europe. And I think there are over 1,000 students you have taught.

MR. KRACK: We are close to 1,500.

DR. LINDHOLM: Plus organizing multiple record attempts and competitions. We are happy to have you here.

MR. KRACK: Thank you. I would like to thank UHMS and DAN for having us here. It is certainly an honor for us to be able to present to you.

What I would like to do in this time is to give you an update of how the sport of freediving has progressed, from where you knew it many years ago to where it is today. We will do that by giving you an account of some of the teaching that we do and some of the special things that have been going on recently.

We will talk about safety techniques and problem management for recreational and competitive freediving. We are going to give you the first part of our intermediate program. We are not going to go into because that would take the full morning, but we want you to understand the scope of the information. The concept is simple - that basic safety protocols and techniques to go with them could take care of most of the incident cases that occur.

But first off, who are we and what do we do? We are Team Performance Freediving International. We have Mandy-Rae Cruickshank from Canada. Mandy is a six-time world record holder. We have Martin Stepanek from the Czech Republic. Martin has held 10 world records and currently holds three. We also have Brett LeMaster with us today.

We have held static apnea records, simple breath-holds for time, in both the men's and women's categories. Similarly, for constant ballast, which is kicking down and up under your own power with a fin. Mandy, Martin and Brett have all held those world records. Ranging back in 1999 for 81 m [266 ft] for Brett, 78 m [256 ft] for Mandy and 108 m [354 ft] for Martin just recently.

Constant no fins, which is swimming down and up on your own power but without fins; essentially you are just breast stroking. In 1999, Brett reached 81 m [266 ft] with fins and last year Martin reached 80 m [264 f] without fins. Mandy has reached 50 m [164 ft].

We also specialize in free immersion, which is simply pulling down and up without fins. Now, free immersion we also utilize as a warm-up technique. You do not just get in, freedive and have your best performances right away. You need to warm up. So we usually use pulling up and down the line as a means of doing that.

Variable ballast, where you ride a sled down and then you fin and pull your way back up. Then, no limits. Mandy has held that world record. That was the one that Tanya Streeter was attempting to beat.

We have been very successful competitively. Martin has won the Cyprus Cup twice. And Mandy's Canadian women's team has placed first in two competitions.

Primarily we are educators. We offer snorkeling and skin diving programs and a very simple, two-day freediver course. We run an intermediate freediver program for scuba divers or those with limited freediver experience. Most of the spearfishermen we deal with take the four-day program, intermediate course.

People typically come into the program with a 30 to 90 s breath-hold capability, and they will end four days later with about four to five-and-a-half-minute breath-holds. They will start off with a 40-50 ft [12-15 m] touch and go, and at the end of four days they are doing anywhere from 100-130 ft [30-40 m] touch and go. We also provide them with information on physics and physiology at the lay person's level. It is important that they understand the body processes and how the environment is affecting them.

Then we offer an advanced freediver program. We have trained almost 1,500 students, including some notable celebrities. We recently worked with David Blaine. He spent seven and a half days immersed in a sphere, which was quite interesting, and then ended it with a breath-hold. The reason we bring this up is to demonstrate the growing popularity of freediving. After this show we know 18 million people in the U.S. alone knew the terms freediving and, static apnea, and saw someone hold their breath and understand the successes and the pitfalls of that.

We also run, for a sixth year this year, an advanced freediving research project at Simon Fraser University. It is a 12 week program for non-freedivers; they can be snorkelers, scuba divers or swimmers, but they can not have been in a formalized freediver program. Testing includes pulmonary function, cerebral blood flow, cardiac output, and much more.

We are trying to enable an open dialogue with researchers. We have an extensive live of people who have completed our programs and are very active. We get questions all the time about squeeze issues, decompression illness issues, and a number of less common concerns. We also have a list of active researchers, such as Dr. Lindholm, Dr. Potkin and others, who we approach to get their feedback.

We also carry out a scientific weekend in July when we will freedive a number of wrecks. Dr. Potkin will be coming up to do some docking testing as well as collect profiles from these freedivers. Dr. Lindholm has visited us previously as a guest lecturer.

We are athletes trying to spread the gospel of freediving, but the safe aspect of it.

The competitive world focuses on challenging time, depth and distance. Time is static breath-hold. Depth has six different disciplines, whether you are powered, self-powered, assisted or not assisted. And then distance has two disciplines, with or without fins.

The overall breath-hold record is 8:58 min:s. The maximum horizontal swim distance is nearing 214 m [702 ft]. The unofficial maximum depth achieved with breath-hold is 209 m [686 ft]. Amazing when you consider that 50 years ago it was believed to be impossible for us to go deeper than 50 m [164 ft] because of residual volume issues. The 209 m [686 ft] dive shows the ability we have as a species to adapt to extreme environments.

Competition can be individual or team. World records are all about having the best conditions on your day and having several attempts.

We compete through the Association for the International Development of Apnea (AIDA). AIDA is our sport governing body. It officiates the sport, provides our judges, maintains the rules. It is a federation of approximately 40 countries around the world. Strict safety protocols are employed.

Typically, an AIDA judge will arrive before your attempt and evaluate your safety procedures. They will decide whether to attend and ratify the effort or not. It is the premier body right now.

Recreational freediving also challenges time, depth and distance. We have people in our clinics who consider themselves recreational. They are not competitive. They see freediving as a means of satisfying a personal challenge or their own competitive nature, and they use it as a way to better themselves, to give them a goal to train for, to see what they can do. The world of recreational freediving is now entering a depth where people routinely play in 100 ft [30 m] of water and beyond. 'Deep' is a relative term.

There is also spearfishing, collecting, photography, video, sightseeing and a lot of different family activities. We see families, 12-year-old son, the mother, father, coming to complete the program with us. It is an easy, entry-level way of getting into the water.

One-third of our customers characterize themselves as ex-scuba divers because they "Got tired of carrying all that heavy stuff." We all share the same passion for the underwater world.

What we are going to do now is review safety and problem management. We are going to look at freediving supervision, blackouts and near blackouts, consider protective reflexes, how we assist and some self-rescue skills. It is important to realize that self-rescue skills do not negate the need for a buddy. What we are going to look at is how you evaluate when you should go deeper, do the same depth again or when you should step back.

First off, to us in freediving, supervision is direct supervision. We know very typically in spearfishing that the boat barely gets shut off when divers are jumping off in 360 degrees. The essential rule is first in, first fish. We think this is an attitude change that needs to change.

Regardless of the time, depth or distance that we target, we require direct supervision. This means one buddy up, and one buddy down. One person performs and one person is the safety. We want to know where a person is and how they are doing at any time during their dive.

The other important aspect of this is that you have to be on the surface to ask if they are okay and get an okay signal back from them. We never trust it though. Most of the people we see blacking out are

giving the okay signal the whole time they are slipping under water, but at least it is showing that they have a process to go through. Most importantly, we need to watch a surfaced diver for 30 s.

We talk about the rule of nines to describe most accidents. Ninety percent of the problems that happen in freediving occur after the person has hit the surface and within three breaths. It is important to remember that there is a delay between breathing and the arrival of oxygenated blood to the brain. This can easily be 15 s. It can be longer with improper recovery breathing when we are suffering from problematic blood pressure changes.

Direct supervision is ultimately the simplest thing. It always amazes me when we see accident reports. The major problem is generally really simple. Someone was not there to keep the airway out of the water. That is what it boils down to. Avoiding that single problem, we could negate 99% of the fatalities we see in freediving. What it will take is a change in attitude.

Now, when we get into freediving supervision, specifically when you have constant ballast and free immersion, the supervision comes down to timing and style. Mandy and Martin will be on a dive. They will see each other coming up. We will know, having observed them for 10 s before they get to us, whether they are in control or not. But even before that we gauging the entire effort. For direct supervision, we know where they are during the whole profile.

For example, we ascend and descend at a rate of approximately one meter per second. For example, Martin may start down on a 100 ft [30 m] dive. Mandy will have her hand on the line. As Martin gets to the bottom, she will be able to feel him grab the line to turn himself around. She will know that at approximately 30 or 32 s, when she feels him turn, that everything is as it should be. If she has to wait 35, 36 or 37 s before the turn she has a clue that the pace is off. Similarly a turn at 25 s indicates something unexpected, perhaps an equalizing issue, perhaps something else. The timing can provide valuable information as to where the person is in the profile.

Mandy does a personal best dive to 85 m [279 ft] kicking down and up under her own power. That dive is 2:47 min:s. Martin's dive to 108 m [354 ft] was four minutes.

When they start their dive I, as a safety, do not go down right away. I could black out waiting underwater for Martin to come up during a four-minute dive. So there has to be a timing issue.

We do not always meet the person at depth. During warm-ups or during very simple dives a lot can be done on the surface. However, when we get to target dives or even dives with a significant sink phase, when you do not have to kick anymore, instead utilizing negative buoyancy or other factors, we need adequate rules of 1/3 to 1/4 of the depth. In both Mandy and Martin's dives I am meeting them at 30 m [100 ft].

When we look at constant ballast from the recreational point of view, we plan on a two to three person buddy team. Routinely we will go out, three of us, to do some depth training. One person is performing right here. One person is a safety. The last person would normally be on the surface near the counter-balance system. They are breathing up because they get to go next and they have a couple of minutes where they do not have to do anything, they can focus on themselves. If the safety has to deal with the performer, the third person jumps in and lends a hand.

We can do this, three of us, well into the depth ranges that Mandy and Martin need to train in, and we will explain that momentarily.

As we get into static apnea and dynamic apnea, think about the sport of static apnea. Very exciting for spectators, watching competitors face down and motionless in the water. You can imagine the television commentator calling for a commercial break.

So, back to the action. Hey, Martin, how is your buddy doing in static right now?

MR. STEPANEK: Oh, pretty good, about 25 min.

MR. KRACK: So how do we know the status of the person? It comes down to agreed signals. Martin is going to give Mandy two taps on a shoulder. She responds with a distinct signal. That would be typical of what we would require during static apnea.

These signals do not start right away. They can begin one minute before the competitor has hit a target time. It is not uncommon for Mandy and Martin to go through four minutes with no signals. They are nice and relaxed. Four minutes is a very straightforward breath-hold for them. And then as the risk increases and the difficulty, the signal exchange comes every 30 s and then every 15 s.

Dynamic apnea involves horizontal swimming in a pool with more obvious signs of competence. For us the biggest warning cue that the person is blacking out will be an unexpected release of air.

These are some of the basics of simple, direct supervision. Now, as advanced and competitive freediving safety systems, as the world of recreational and competitive freediving progresses in its depth, so do the safety systems. Relying on a buddy system, one up, one down, is not sufficient. We developed freediver recovery systems, both passive and active systems. The most important element is a lanyard. We can have, for example, a wrist lanyard formed by one meter of cable attached to a carabiner hooked around the competition line. We cannot come off that line. We may be in a 3,000 ft [914 m] column of water, so we cannot afford to have a recovery problem at depth.

We have developed a counter-balance system. It has two floats held apart by a 10-12 ft [3-4 m] aluminum pole. Under each float is a pulley. The continuous line goes up through a pulley, through the second and then down. In between we have two sailing clutches in opposition to each other to prevent the line from moving. At the bottom end, the competitor end, we have an amount of weight. On the counter-balance end we have double the amount of weight on the competitor end.

The system is useful when we do not have safety divers underwater (required for competition and official record attempts). The system works because when Mandy is doing her dive and Martin is safetying, he knows when he has to see her making way to the surface. If he does not, he signals me positioned by the counter-balance. I release the clutches, the heavy weight drops and the light weight comes to the surface. It pulls the carabiner that she is attached to and she is coming to the surface at a rate of five to six feet per second [one-and-one-half to two meters per second], faster than she would swim to the surface.

This system eliminates the risk of not being able to extricate the person from depth. We can get them to the surface faster than they can get there on their own. The device is simple. Four, one meter pipes that hook together, a bunch of floats and some line.

Another device we use is line-assisted freediver retrieval system. This requires safety divers and is typical of what we would do for competition events. Integral to the system is a 13 to 40 cubic foot bottle, depending on the target depth. The other major pieces are a lift bag (up to 150 lb [68 kg] of lift if a sled is to be used) and climbing clamp. The safety divers within 20 m [66 ft] of the target bottom. They watch for the person to touch the bottom plate and begin a 10 s count. The competitor has to be

away and moving towards the surface by the end of the count. If not, the clamp is set on the diver's lanyard. The valve is opened to fill the lift bag and the freediver is immediately carried to the surface. The system lifts 20 m [66 ft] of line with the freediver attached to it.

Another option is diver assisted. It is the same contraption to that which I just described but with a carabiner on it. In this case we might have safety divers right at the bottom. Should the freediver have a problem, the safety diver simply attaches the carabiner to the down line, opens up the valve to fill the lift bag and the lift bag runs up the line, pulls the lanyard and brings the freediver to the surface. Alternatively, the carabiner can be attached directly to the freediver. The ascent speed will again be well over $1.5 \text{ m}\cdot\text{s}^{-1}$.

When we do our record attempts in Cayman, we have all three systems available. We did the same for the 2004 world championships when we utilized all three.

We are now going to talk about blackouts and near blackouts. To set it up I will describe a guy and his buddy coming from Alaska for our course. We asked them, what do you hope to get out of this program? The first said, "I hope to black out." Strange objective for our course, the first time we heard it. "Because," he said, "I want to know when I am getting close. I want to feel what it is like. I want to know all those precursors leading up to it." OK. We figured he could meet his objective.

We then ask his buddy what he hopes to get out of the course. He says, "I want to see him black out. I want to know when he is going out. I want to see what it looks like."

We set up a system for people to really explore their potential in training. We graduate them in safe and appropriate increments but, occasionally, some step over the line. We tell them not be embarrassed by this because the learning is important. After someone has pushed a little too hard in static apnea, for example, we talk about what was it was like, what the person remembered. Then we ask the buddy what it was like for them and what they remembered.

Most importantly, we get rid of the "Oh, my God" factor, because they have seen it, they have experienced it, they have tasted it. And in the ocean they are more likely to respond right away. Most importantly, it drives home the fact that it can happen. If you are in our sport long enough, regardless if whether your activity is recreational, spearfishing, or competitive, you will likely experience a hypoxic episode that is going to inhibit your ability to take care of yourself.

We must be careful with definitions when we talk about things like blackout and loss of motor control. We still talk about shallow water blackout, but we really want to start referring to it as the ascent blackout. It is the re-expansion of the lungs and that vacuum effect that Terry Maas coined.

Then there is static blackout, simply outstaying your ability for the amount of oxygen.

There is recovery blackout, improper recovery breaths at the surface that can change blood pressure issues.

Then there is barotrauma blackout; barotrauma being perforating an eardrum and having severe alternobaric vertigo at depth.

We also have the rule of nines. The rule of nines comes from our dealing with 1,500 students, working with the U.S, Canadian, and British teams, and all the competitions that have confirmed that 90% of the problems we are going to have are going to be at the surface. The person will get to the surface, take three breaths and have a little shake and they might be okay or they might progress into

a blackout. Nine percent will happen five meters [16 ft] to the surface. And that would be the shallow water or ascent blackout. Deeper blackouts normally occur with competitive type divers where the appropriate level of supervision and safety is maintained.

The deepest I have ever seen anyone black out was 25 m [82 ft], but we had also been following the person from 40 m [131 ft] on up. The person recovered within 15 s of hitting the surface. Outcomes can be bad unless you have proper supervision in place.

Now, there is a difference, depth versus static. Depth, when you are coming up, the re-expansion, the hypoxia comes on very quick. You might be ascending and thinking, am I feeling tingly? And then by the time you process that thought, you can be out. Whereas, static hypoxia sneaks up on you. Am I feeling tingly? No, I am not. I will go to the next signal. Maybe I am feeling a little tingly. Maybe I should – then you go. It sneaks up on you. You do not really feel the symptoms as you should.

When we are looking at blackout or near blackout or loss of motor control, it is important to understand the signs and symptoms. We provide the safety for confusion and faulty judgment, emotional instability, cyanosis, loss of motor control and convulsions.

What do we feel? We feel a euphoria, a dizziness or a confusion. We have seen competitors who go to take their hood off before they have taken their mask off, that type of confusion. A tingling and numbness that is obviously occurring in the extremities and working towards the peripheral nerves. A loss of motor control, visual disturbances, and hearing disturbances.

The safety sees a loss of motor control. He or she moves in to provide support, most importantly, to protect the airway. If all you ever did was grab the person by the hair and kept their mouth out of the water, they would eventually recover on their own. What we teach is how to promote recovery quicker and more efficiently.

Our standard protocol following a blackout is to have the person checked out by the medic, breathe oxygen for five minutes, and then remain as a surface person.

We would consider an event a blackout if, without support, the victim could not keep his airway out of the water. Even though his eyes are open, he is breathing and giving you the okay, maybe even looking you in the eye. As soon as you can not protect your own airway, we consider that a blackout. So it is all the signs of near blackout, plus loss of consciousness or loss of respiratory control.

The time course is critical. It is important to remember that a person can surface clean and look fine, then slowly start to take a little nap. The safeties must remain on guard.

This is probably the vast majority of spearfishing problems. Get to the surface, overweighted, improper recovery breaths, a delay. Buddy might even have seen you hit the surface and think you are fine. Then as the buddy goes down to grab a fish, you black out on the surface, exhale and sink back down to depth. Terminal gasp kicks in, water flows into the lungs and the downward spiral continues.

Now, protective reflexes. Laryngospasms are great. We encourage our students to talk and drink. We want a really responsive laryngospasm.

When we hit the surface, we look for three things. Breathing, trying to move air, and no breathing. We may see rhythmic contractions and hear the air being moved out of the mouth so we know that even if there is a little bit of laryngospasm, it is not locked. The standard protocol for us would be 10 s of blow, tap, talk, and then provide basic life support.

Or the next thing we would see, the victim could hit the surface, black out, and there is no air movement, but there are significant contractions. So what do we know here? Laryngospasm. Well, still within 10 s we do our blow, tap, talk. Then, if we needed to, we would apply positive pressure like anesthesiologists do to help relax that.

Or what we would see is this. We would see absolutely nothing because we can also have a cessation of that breathing response. No contraction. You do not know if there is a laryngospasm or not. All you know by what you are taught is within 10 s you start two breaths and then maintain a breath every five seconds from there, basic life support. Very simple what we teach in the program.

Now, all of this is good, but recovery breathing could take care of most things. Recovery breaths, we teach that the first six breaths you take are going to be the most important breaths you take. Just because you hit the surface does not mean the job is done. You are not safe yet. You are safe when the color comes back into your lip and your buddy tells you and gives you the okay.

We hit the surface, we do our six recovery breaths, give our buddy the okay, and our partner might say, keep breathing, because you are still cyanotic. And then we keep breathing until we see good color come back.

Static recovery breathing is a little different. We breathe from the top of the lung. We want to keep the tidal volume up. When we breathe low on the low end, we lower volume, we lower blood pressure, and we can have delivery issues. In depth recovery breathing we use what we call 'hook breathing,' meaning that with the first three breaths you are going to pause at the top. As our lungs re-expand and we are changing blood pressure and blood distribution, we want to take that breath, hold it at the top to force the lungs with full of air to make sure that we do not have blood rushing to the lungs and not maintaining circulation to the head.

We say we pioneered hook breathing, but we did not. We pioneered it for freediving, but hook breathing has been used by the Air Force for quite a while.

How do we assist the blackout and near blackout? It is very simple. The person hits the surface. They might get three breaths into them and then start to go out. The safety moves in and uses a hand to protect the airway. If the person blacks out, he or she will not take on water. Physical support is provided along with encouraging talk.

Ascending from depth, if begins to develop problems, the safety can grab him and the line and pull to the surface. Dropping the weight belt is an option. An option because in competitions you may have six scuba divers below you who do not want a 10 lb (4.5 kg) weight belt coming down in a hurry.

Surface blackouts generally start with a loss of motor control. Full blackout requires protecting the airway, getting the person onto his back into a recovery position, and removing the mask. Then, the magic breath. That is blowing across the eyes to stimulate the breathing response. We see it so often. Person is blacked out, remove the mask, blow to create evaporative cooling, and that is what you get. Blow, tap, talk, we do this three times.

Now, ascending, a clear indication of blackout is loss of airway control. When bubbles start coming out, the safety moves in, closes the airway, leaves the mask in place, pinches the nose if feasible, and brings the victim to the surface.

The important thing here is protecting the airway. The body has an amazing ability to recover on its own, and we see this all the time.

There is no need for anything aggressive. You do not yell. You do not create an environment that the body does not want to come out of unconsciousness to. If you are sitting there, breathe, breathe, it says, whoa, danger, I am safer unconscious than I am coming back to here. So we want to promote an environment in which you want to become conscious.

An important question for most freedivers is how to increase target depth. It is about teaching people to be progressive. You do not jump from an 80 ft [24 m] capability to try 130 ft [40 m] the next day. Instead, small, progressive steps, in 10 ft [3 m] increments. It is not always about getting deeper. Sometimes it is about doing that depth over and over until you feel really comfortable.

When our students do a dive, they are going to evaluate eight things.

Near blackout. Did they suffer a near blackout or an oxygen issue, did they see stars, that sort of thing.

Contractions, were their contractions strong or did they have pressure contractions. On the way down did they feel the urge to breathe suddenly and then if they turned around, it went away.

Did they undergo any narcosis? Was there a decompression illness after? Mandy and Martin practice in-water decompression. After they have done a performance and the judges have given them the okay, they go down to 6 m [20 ft] on oxygen for five to 10 min as a precaution when we are doing multi-dive days.

Chest squeeze. Was there a problem with lung or tracheal squeezes in bringing up blood?

Tired or burning legs.

Could they equalize at the bottom?

Did the equipment work out and was their technique right. If they say no or there was a problem with one of these things, they might do the same depth. If there are multiple things, they might repeat or step back. And the important thing is all about going in and being a progressive freediver.

So that is a little bit about our sport, us, what we do, where the sport is at, and very simply what a person in an intermediate program would go through. You know all you need to take care of 99% of the fatality statistics that we see.

It is one thing to look at them and say, wow, we had a PCO_2 increase and an O_2 drop here and that triggered this effect and that effect. It is even simpler than that. These people died because there was no one there to grab the airway. And that is what we are trying to get across. Education and understanding and attitude change to dive with a buddy is going to be everything to maintain the sport and to keep it safer. Thank you.

WORKSHOP DISCUSSION

DR. HAMILTON: Air crew members are exposed to altitude in a pressure chamber, low-pressure chamber, and their masks taken off and given the experience of feeling what hypoxia is like so they know how to anticipate it. They are given a tablet and a pencil and told to write what they are feeling. Of course, if the writing gets big and goes off the edge of the paper, the mask goes back on, their

writing continues normally. It is necessary to do that in order to convince them that they have had hypoxia. They see what they were writing.

Do you have this denial thing? You are focusing on blackout. Do you have people denying that they have been hypoxic?

MR. KRACK: Oh, absolutely. And it is interesting because we will have people that have blacked out. You take care of them. Take their mask off. Then they come around, they look at you, what are you doing? You just blacked out. No, I did not. I am fine. I remember the whole dive. No, you did not. And they are flabbergasted.

Well, how did your mask get on your forehead? Why are you sitting on the pool deck right now. It is the X factor, right? Aliens come down, take you to the mother ship for 15 s, bring you back, and you have no recollection except your mask is suddenly on your forehead.

When I was working in Cayman, I used to give people the experience of blackout. I would put them on a Draeger rebreather, then turn the oxygen supply off and have them report any symptoms. They were to raise a hand, respond to a question, and come off the circuit. More often than not, we had to take them off the circuit.

Blackout can either be very quick or sneak up on you. When you are competitive, it is your job to go for it. But most of the time people do not even know they have had an issue.

MS. CRUICKSHANK: We videotaped all the courses, so when they are truly in denial, we can put the video in and show them what they looked like.

MR. STEPANEK: It is a little bit different from the dive itself, because you have the drive to breathe from a high level of CO₂. So you are aware that you are running low on oxygen because it is uncomfortable because of the CO₂.

DR. LUNDGREN: I just want to suggest perhaps a clear distinction between vertigo resulting from a broken eardrum, which you pointed to, which is known as caloric vertigo, and the effect of cold water entering the middle ear versus alternobaric vertigo. And the reason we should make that distinction is that people should not think that if they have not broken an eardrum, there is no risk of vertigo. Because alternobaric vertigo, as I mentioned yesterday, but I want to underscore it so there is no confusion about it, the mechanism there is the effect of changing pressure in the middle ear, where the change of pressure in the middle ears is unequal on the two sides, right and left. And it is particularly likely to happen during ascent.

MR. KRACK: It is our mistake for just kind of lumping it into one thing, being a pressure and temperature differential. Thank you.

DR. SMITH: The hook breathing is really fascinating to me. I guess the anesthesiologist would appreciate it as a CPAP [continuous positive airway pressure] because that is basically what you are doing.

I guess my question would be, have you had people do the hook breathing and still pass out on the surface, and if so, I would think it would be a very low percentage.

MR. KRACK: No. We have had people who even with the hook breathing cannot maintain consciousness. They have usually pushed themselves and are going out no matter what. The breaths they take before going need time to do any good.

MS. CRUICKSHANK: It is usually that they do not get to finish all of the hook breathing and the recovery breaths. They will get one or two in before they go out. They are so deprived at that moment that they do not have enough in them to get all the hook breathing in.

MR. KRACK: We think a significant factor in blackouts that occur at the surface is that people tend to breathe at the low end of their tidal volume, and that creates a blood pressure disruption.

DR. SMITH: This is a minor detail, but have you ever experimented with both the amount of time you keep the pressure on and the intensity of the Valsalva? Because it really, from just looking at people who are on ventilators when you put them on positive expiratory pressure, you can just see in a matter of a change of five centimeters or something lung and tissue open up. So I would think it would be an interesting experiment. It would be fairly simple to actually check how long do you Valsalva, and how long do you hold it, and what is magic about four versus two or six.

MR. KRACK: No, that is a really good point, and we would like to see some research. There are lots of things we would love to throw at this audience to research. That would certainly be one of them.

And, you know, the reason why we did six and three and three and stuff like that is simply because we wanted to come up with some form of protocol, some number. We wanted to start to engrain it. And the number also comes from the fact that within AIDA, for us to ratify a performance as being good, within 15 s after hitting the surface, we need to look the judges in the eye, remove our mask, give an okay signal, and then say I am okay in that order. If we can not complete that within 15 s, we are disqualified. We are deemed to be out of control. And, obviously, we cannot black out and we are observed for a total of a minute. But we have that very strict 15 s protocol.

So our breathing also comes trying to fit within the competitive parameters as well. Mostly we try to engrain in our students to always practice your recovery breaths. You step out of the shower, it should be recovery breaths. So that when you are at a point in your dive where you are hypoxic and you have just blown off your CO₂ and you are in that euphoric state, subconsciously hook breathing will come into play and you will avoid a bad situation.

DR. SMITH: It is something so simple, I would wonder, is it generally well known like in diving magazines? This ought to be as simple as remembering to put on a seatbelt.

MR. KRACK: Within the competitive community I think it is fairly well known. Probably not within the spearfishing community.

DR. MACRIS: I practice emergency medicine. Your safety record is incredible. What are your plans when things go wrong? Not so much in the pool, but when you are out in the open water? What do you do in case you lose that airway on the way up or that person does seize and takes in a lung full of air and goes into acute bronchospasm and ARDS [adult respiratory distress syndrome], what is your preparation? What do you do for that?

MR. KRACK: During competitions and records it is really simple. Get them to the surface, take them to the boat, which is by standards and protocol supposed to be no further than 20 feet away, and give them to Dr. Potkin and his paramedic.

DR. MACRIS: So you have a physician trained in airway management?

MR. KRACK: We are required to have advanced life support, airways and a defibrillator and appropriate professional staff on site. We have to be able to take care of drowning protocols.

DR. MACRIS: I feel better about that. Because even in a trauma room with the best of the best circumstances, situations can be challenging.

MR. KRACK: We have to maintain at least two emergency personnel and have an evacuation plan and protocol. The safety protocols are very strict and proscriptive.

DR. SHANK: You were discussing the training both for amateurs and the professionals. What are the physiologic factors or their limitations to extending it another meter or two? Is it purely tolerance to hypoxia? Is it athleticism? What factors?

MR. STEPANEK: It is just like in any other sport. Everybody has gifts in something and flaws in something else. It is not a one thing that makes you a great freediver. It is a combination of many.

For each different freediver it is a different thing that holds them back. For some people it is the equalization. For some people it is nitrogen narcosis, chest squeeze, or the mental aspect. We do not know. There is no general thing that would hold us back as a species from going deeper than we are going now.

MR. KRACK: Individuals certainly have advantages. For example, Mandy's lung volume is 163% of that predicted for her height, age and weight. Martin's is 196% of predicted. They both can just simply manipulate their Eustachian tubes to open and close. Those will be their physiological advantages that will set them apart as competitors.

DR. SHANK: I understand. And a lot of that, I mean, is their anatomy and physiology. But you said no one goes and does that record dive. They work up to it. Is there a phenomenon that happens during that? Is it mind set or body? I mean, you did not develop your lung volume?

MR. KRACK: There is a lot of technique. We have some of our students in the audience. Mark, where did you start and where are you now?

MR. ALAN: I had been snorkeling for a long while along with scuba diving and my deepest depth, and I struggled to get to 60 ft [18 m]. After the last advanced breath-hold course I was at 150 ft [46 m]. There was some training but I think it was 90% technique.

MR. KRACK: Our basic course is surface to about 20 m [66 ft] in two days. Intermediate is basically down to 40 m [131 ft]. We call diving deeper than that advanced freediving because it requires advanced techniques. We are getting into issues with total lung volume to residual volume ratios. So, equalizing techniques are completely different at that point. Stretch receptors, urge to breathe, pressure contractions, risk of squeeze, all of these different things will start to come into play beyond 40 m [131 ft]. Certainly some before that, but very significantly as you move deeper. So that is when we separate an advanced level student.

A lot of the intermediate program is teaching people to bring out their physiology. We are ingrained with it. Whether you want it or not, you all have diving reflex. You cannot get rid of it. It all depends how much you use it and how early on in life you used it.

MR. ALAN: One other quick comment. Another aspect of it was mental. It helped knowing that I had the correct supervision. It takes away that potential limitation of the fear or the anxiety or the tenseness to get the depth. Direct supervision and knowing it is there is a huge factor.

DR. BENNETT: You have given a very good presentation of the safety factors that you use, which are very fine. But as you said, your techniques are not all well known. I encourage you to write articles for the dive magazines to promote safety so that we do not get more of these young men or women having accidents on their own.

MR. KRACK: I agree with your concerns. The frustration we have is in approaching dive magazines is that we often hear that they have "Done our freediving piece for the year." There is a resistance to freediving. It feels like, let us not talk about it, people will not do it, because it is a cowboy sport. Or they are freedivers, we are scuba divers. Maybe we are impinging on an ego thing.

We find it almost impossible to get freediving articles published. And, you are right. I think there is a lack of information out there. In my personal opinion, it is the responsibility of the dive magazines to step up and address the issue of freediving because the potential for freediving over scuba diving is a lot bigger. When you look at the amount of people that jump off a cruise ship to go snorkeling, we consider them freedivers, with one simple technique change and a longer pair of fins maybe, to be freedivers. Until dive magazines actually start waking up and addressing the issue and then allowing the articles.

DR. BENNETT: Perhaps some of us here can influence the magazines.

MR. KRACK: We would all appreciate that.

DR. FOTHERGILL: What kind of regulations do you have regarding taking medications before a dive? And I am thinking more like the decongestants. And do you find they actually work for helping clear?

MR. KRACK: We do not recommend taking any form of medications. However, let us talk about the reality of it. A person comes to our course and they have traveled and they have made a significant investment. Sinus issues and decongestion is going to be a problem.

So, for example, Musinex, is commonly used. For people that have had deviated septum, Nasonex or Flonase, which is a two-week prior course of treatment. Going to see their ENT is important.

Mandy and Martin are not going to spend \$80,000 on an aborted record just because a sinus is a little sticky. They are going to take Afrin. The most desirable choice would be one not affecting heart rate.

MR. LANG: Do you have a prevalence of reverse blocks?

MR. KRACK: That is a good question. Occasionally. I have experienced one once.

MS. CRUICKSHANK: I have had one once or twice. I frequently have bad sinus issues. I will get annoyed at the fact that I went all the way out there and I am in my suit ready to dive and I cannot equalize. So I will work my way down, equalizing nice and slow doing a pull down, and then I have to go up slowly as well because you can hear squealing. Fortunately, it is not that bad too often. If it is that hard to equalize, you are not getting deep anyway.

MR. KRACK: I have not experienced nor had students that we knew of who experienced extreme pain or rupture.

MR. LANG: You showed a video clip one of your locations being Pacific Northwest. Do you find that there is a difference between tropical waters and cold waters in ability to clear ears?

MR. KRACK: Absolutely. The colder water tenses you up so you are not as flexible in being able to manage gas movement, which is important. Plus just the cold on the ears can be a hindrance. So we use Doc's pro plugs and similar products that help to prevent surfer's ear and trap the water. Half a cotton ball in each ear, things like that. There are certainly more equalizing issues in cold water than warm water.

DR. MUTH: I am sorry, but I have to disagree with you about diving publications. I have spent 12 years as a medical editor for a German diving magazine. We frequently run articles on apnea, and report world record performances. The editors ask the readership what is wanted in the magazine. And 90% of the readers, which are ordinary scuba divers, said less apnea diving.

Maybe they are just jealous. When they are in their training, they just do a 25 m [82 ft] dive and are out of breath and see what those guys do. Maybe there is something else, but we cannot influence the readers' if they are not interested. That is a big problem.

MR. KRACK: We can very rarely get a press release in a success we have had in a world record. And in Europe, you see far more apnea covered in magazines than you do in North America, a lot more. But, you know, in 10 or 15 years that will change. It will be the scuba divers screaming to get their articles in as the freediving community takes over.

GLOSSOPHARYNGEAL BREATHING AND BREATH-HOLD DIVING ON EMPTY LUNGS

Peter Lindholm, MD, PhD

Swedish Defence Research Agency, Centre for Environmental Physiology,
Karolinska Institutet, Stockholm, Sweden

Introduction

Glossopharyngeal breathing has been called numerous things including frog breathing, lung packing, buccal pumping, and carpa. Breath-hold divers use glossopharyngeal insufflation (GI) to increase the volume of air in the lungs above normal total lung capacity (TLC) or glossopharyngeal exsufflation (GE) to reduce the amount of air below normal residual volume (RV) (8). GI will increase the volume of air up to 50% of that subject's vital capacity. Collier et al. (3) showed, in patients with reduced respiratory muscle function, the increase in pulmonary gas will cause a drop in arterial blood pressure, an effect that can explain an observation that is often noted among breath-hold divers who use too much GI; that it may cause syncope. There are also some anecdotal reports of pulmonary barotrauma after GI. When GI is performed there is an increased circumference of the thorax. Certain divers who are able to insufflate large volumes expand the chest significantly, giving them a barrel chest appearance. It is possible that they have increased their articular mobility and stretched their respiratory muscles so they can increase the chest volume to whatever is anatomically possible. The pressure will reduce the amount of blood in the chest which will give more space for air. The high pressure will also compress the gas in the lungs: pressures of about 10 kPa (75 mm Hg) have been reported (11), which would be equal to about 10% extra air due to compression. This study also reported transpulmonary pressures as high as 8 kPa (60 mm Hg).

In a six week study of GI in 16 healthy women (not divers) it was reported that they learned the technique, and that vital capacity (without GI) had increased significantly by 3% after six weeks (9). GI was performed cautiously with volumes corresponding to 10-25% of VC. Another effect that was noted was that after each session of GI, the VC was increased when measured, indicating a 'warm-up' effect. In fact it is very common that breath-hold divers perform stretching and GI/GE maneuvers to prepare for a dive, possibly increasing the flexibility of the chest and diaphragm.

GE is used at depth to fill the mouth with air to enable equalization of the middle ear by a Frenzel maneuver (this enables the diver to abstain from using a Valsalva maneuver at depth). GE is also used to simulate the 'squeezing' effect of deep breath-hold diving by performing GE after a full exhalation and thus enabling the diver to partially practice the effect of an extremely low gas volume in the thorax, but dry. Studies of GE with magnetic resonance imaging have shown that the volume of the trachea is reduced. In one subject the extrathoracic portion of the trachea was severely distorted and almost collapsed (8).

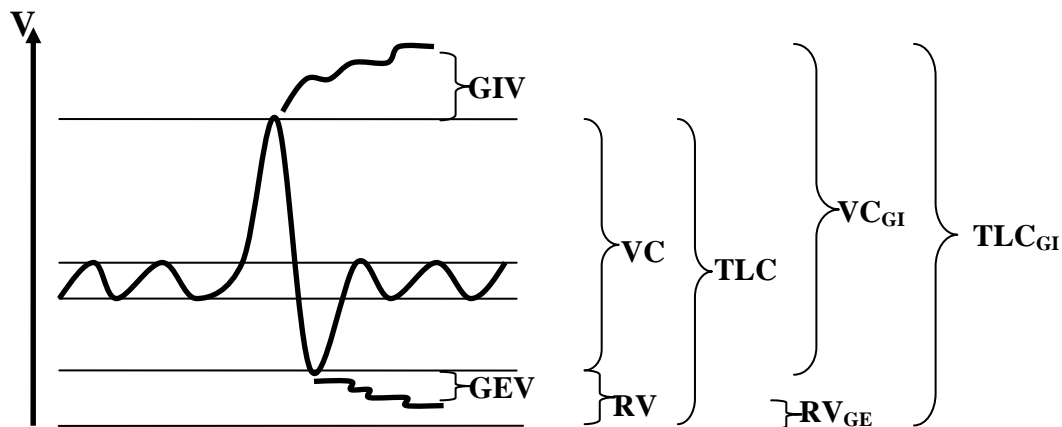

Figure 1: Schematic of lung volumes and glossopharyngeal breathing with the different manoeuvres glossopharyngeal insufflation (GI) and glossopharyngeal exsufflation (GE). GI add air to the lung, while GE withdraw air from the lung. Volume (V), total lung capacity (TLC), vital capacity (VC), residual volume (RV), glossopharyngeal insufflation volume (GIV), glossopharyngeal exsufflation volume (GEV).

Pulmonary squeeze

There are a limited number of reports on the effect of squeeze during deep breath-hold diving. Craig (4) and Shaefer (10) showed the effect of blood shift during breath-hold diving, i.e., that when the air in the lungs is compressed by the hydrostatic pressure, there is a redistribution of blood into the thorax, that similar to the effect of immersion but more pronounced. This effect reduces the effective residual volume in a diver, thus enabling the diver to dive much deeper than can be predicted by the TLC/RV ratio from a measurement non-immersed. At some point, however, the lungs will be squeezed to a very low lung volume (i.e., the current official depth world record in No limits is 183 m (600 ft); with unofficial reports of a dive to 209 m [686 ft]), so how will the lungs react to this effect? There are two published cases reports (2,5) concerning hemoptysis after breath-hold diving to relatively shallow depths. Other studies focusing on swimming or scuba diving have described hemoptysis together with pulmonary edema, i.e., swimming-induced pulmonary edema (SIPE) (1,6). When a breath-hold diver dives deep enough to compress the air to a volume less than the residual volume (the RV measured immersed) it could be argued that three different mechanisms would cause a further reduction of the space in the lungs and airways: collapse of airways and alveoli (atelectasis), pulmonary edema with fluid entering the alveoli, airway and/or interstitial spaces and bleeding with blood filling the void.

The use of GE together with diving in a shallow pool enables divers to simulate the squeeze of great depth in a relatively safe environment. This diving technique enabled us to simulate and study some of the effects of squeeze in breath-hold diving in the comfort of our laboratory. We hypothesized that diving that way would cause a squeeze effect could lead to edema of the conducting airways.

Methods

Eleven divers (10 male) performed dives during 20 min in our 6 m (20 ft) deep pool, in thermoneutral water (35-36°C/95-97°F). The dives were performed after the diver had exhaled maximally and used GE to further exsufflate air from the lungs while submerged to the neck. The subjects were

experienced breath-hold divers who had practised this specific type of diving previously. Some divers previously had had hemoptysis after breath-hold diving to depth of 30-50 m (98-164 ft). Subjects were studied by dynamic spirometry and video-fibero-laryngoscopy before and after the dives.

Data from the male subjects are presented at mean \pm standard deviation. Paired t-test for dependent samples was used. Significance was accepted at the 5% level.

Results

By calculation of lung volumes measured with GI and GE, and adding the diving depth of 6 m (20 ft), the squeeze effect of these dives was, for certain individuals, comparable to a diving depth of about 100 m (328 ft) in the sea. Diving time with empty lungs ranged from 0:30 min:s to 2:00 min:s. Forced vital capacity was reduced from a mean of 6.57 ± 0.88 L to 6.23 ± 1.02 L ($p < 0.05$). Forced expiratory volume in the first second (FEV_1) was reduced from 5.09 ± 0.64 L to 4.59 ± 0.72 L ($p < 0.001$). Several subjects reported a (reversible) change in their voice after the diving which was clearly noticeable by the investigators. After diving, fresh blood was found by laryngoscopy in two subjects. This blood originated from somewhere below the vocal cords and was documented on digital camera (7).

Discussion

Many breath-hold divers report hemoptysis after deep breath-hold diving. The anecdotal reports are usually of two types, one which describes specks of blood in saliva after spitting and a more serious type, with more blood and/or mixed with fluid from the lungs. In this experiment we could observe a mild voice change in all subjects, possibly due to a slight edema of the vocal cords. We also had two cases of mild hemoptysis among the 11 subjects.

During breath-hold diving, blood pressure increases tremendously, due to the diving response. The pulmonary circulation is further affected by the blood shift which increases the amount of blood in the thorax. During a dive with low lung volume, the airway pressure will be relatively low. The conducting airways are not prone to collapse because of the structural properties of cartilage, a notion that could suggest that the edema produced by the squeeze could be noticeable in the airways. The reduction in dynamic spirometry results from diving suggested that there could be edema of the conducting airways.

It has been suggested that the minor bleedings that present without coughing could originate from the airways, possibly from vessels in the trachea or bronchi which will be highly affected by the squeeze (8) but this still remains speculation.

The more serious type of bleeding (2,5) resembles the symptoms of swimming-induced pulmonary edema SIPE (1,6), which often presents as dyspnea, cough, hypoxemia and sometimes hemoptysis. On physical examination and x-ray there are often signs of pulmonary edema. The treatment is usually symptomatic and conservative, basically oxygen and sometimes beta-2 agonists, and symptoms are usually normalized within 24 to 48 h.

Conclusions

The effects of squeeze are currently not well studied. The knowledge about the recovery or risks of long-term damage from breath-hold diving induced bleeding is also scarce.

References

1. Adir Y, Shupak A, Gil A, Peled N, Keynan Y, Domachevsky L, Weiler-Ravell D. Swimming-induced pulmonary edema: clinical presentation and serial lung function. *Chest* 2004;126(2): 394-9.
2. Boussuges A, Pinet C, Thomas P, Bergmann E, Sainty JM, Vervloet D. Hemoptysis after breath-hold diving. *Eur Respir J* 1999; 13(3): 697-699.
3. Collier CR, Dail CW, Affeldt JE. Mechanics of glossopharyngeal breathing. *J Appl Physiol* 1956; 8(6): 580-584.
4. Craig AB Jr. Depth limits of breath hold diving (an example of Fennology). *Respir Physiol* 1968; 5(1): 14-22.
5. Kiyani E, Aktas S and Toklu AS. Hemoptysis provoked by voluntary diaphragmatic contractions in breath-hold divers. *Chest* 2001; 120(6): 2098-2100.
6. Koehle MS, Lepawsky M, McKenzie DC. Pulmonary oedema of immersion. *Sports Med* 2005; 35(3): 183-190.
7. Lindholm P, Ekborn A, Gennser M. Pulmonary squeeze and hemoptysis after breath-hold diving; an experimental study in humans. 29th Annual Scientific Meeting of The European Underwater and Baromedical Society on Diving and Hyperbaric Medicine 2003: 38.
8. Lindholm P, Nyren S. Studies on inspiratory and expiratory glossopharyngeal breathing in breath-hold divers employing magnetic resonance imaging and spirometry. *Eur J Appl Physiol* 2005; 94(5-6): 646-651.
9. Nygren-Bonnier M, Lindholm P, Markström A, Skedinger M, Mattsson E, Klefbeck B. Effects of glossopharyngeal pistoning for lung insufflation on vital capacity in healthy women. *Am J Phys Med Rehabil* (*in press*).
10. Schaefer KE, Allison RD, Dougherty JH, Jr., Carey CR, Walker R, Yost F and Parker D. Pulmonary and circulatory adjustments determining the limits of depths in breath-hold diving. *Science* 1968; 162(857): 1020-1023.
11. Loring SH, O'Donnell CR, Butler JP, Lindholm P, Jacobson F, Ferrigno M. Transpulmonary pressures and lung mechanics with glossopharyngeal insufflation and exsufflation beyond normal lung volumes in competitive breath-hold divers. *J Appl Physiol* (*in press*).

WORKSHOP DISCUSSION

DR. POTKIN: Very interesting, fascinating. We tested some of the people here from Performance Freedivers. We did echoes on them after they had packed, and the blood pressures went from 110/60 mm Hg or so to unrecordable. And what we found is that the left ventricle got very small, but the right ventricles were all dilated. I do not think the right ventricle can not empty into the lungs so it gets distended and it is acting like an increased pulmonary vascular incidence from an after load effect on the right ventricle.

When you showed your MRI studies, it looked like the whole heart was smaller. What we found was the left heart was much smaller, the right heart actually was dilated.

DR. LINDHOLM: That is very interesting. The MRI studies we did, MRI, they were not negated with the heart. The heart images are not that accurate as an echo would be. It is just a rough estimate of the size. And it is very interesting you say that you have a high volume in the right ventricle, which sounds very reasonable because if you have such a high pressure in the lung, you will not get any blood through the lung. That is where the stop is, so to say. Very nice.

DR. SCHAGATAY: I was wondering if you have any solid data on direct measurements on compliance? I remember you mentioned that half a year ago in Pisa, but you did not present it here.

DR. LINDHOLM: The measurements of compliance was done by Dr Loring and his co-workers in a study organized by Dr Ferrigno. We published some of the data at the American Thoracic Society meeting 2006, showing 100 cmH₂O relaxed airway pressures and transpulmonary pressures of up to 80 cm H₂O. And that manuscript is in preparation

[Loring SH, O'Donnell CR, Butler JP, Lindholm P, Jacobson F, Ferrigno M. Transpulmonary pressures and lung mechanics with glossopharyngeal insufflation and exsufflation beyond normal lung volumes in competitive breath-hold divers. In press J Appl Physiol 2006].

DR. SCHAGATAY: What data did they conclude from that, do you know? Because we have some indirect measurements suggesting that compliance can be changed over time.

DR. LINDHOLM: No, we have not done any compliance measurements over time. That compliance measurement was just done at one testing occasion in a few divers like Martin Stepanek.

DR. SCHAGATAY: Thank you.

DR. HAMPSON: I am interested in what you suggest telling these people who have recurrent hemoptysis after breath-hold diving. Specifically, I have a 31-year-old patient who in the last two years she has a day of hemoptysis every time she dives below 43 m. Is there any evidence for a cumulative injury?

DR. LINDHOLM: That is a very difficult question. I would like to split it up in a few different answers. One is, first I would say technique. If you learn to dive properly, you might significantly reduce the effect. For example, if you go deep down, your lungs is compressed. You do not want to have diaphragmal contractions at depth when the lung is empty because the contraction will pull down the diaphragm and stress even more negative pressure on the blood barrier. For example, Martin Stepanek tells me that when he dives below 100 m [328 ft] he gets his contractions from 60 to 70 m [197 to 230 ft] on the way up. He does not have contractions at the bottom depth.

There is also other techniques. Like if you learn how to do the mouth fill technique and equalize with less stress on the chest, that could probably affect this as well. And then you have, of course, probably some people would have their limit at some of those depths. And 43 m [141 ft] could very well be this patients limit depending on the lung volume she has and how flexible the chest is.

It seems like some people are genetically able to compress very much. Tanya Streeter, for example, and Mandy and Martin, they are very flexible at depth because they do not bleed. But learning technique is one thing you could recommend.

The other thing is the long-term effects of this bleeding. I do not know. I talked to some persons in high altitude pulmonary edema research and they told me that they have snowboarders coming down when the lift closes at 4:00 p.m. with arterial oxygen saturating of about 60% and they can sometimes have pink, frothy sputum, bad edema. They put them on oxygen for 24 h, and three days later they are back out on the ski slopes. And they do not seem to worry about it. Except that 1 in 100 cases of very bad edema goes into ARDS.

Where we stand now is that there is very little research done on hemoptysis and breath-hold diving. There are two papers out, and there are some studies done by Italian scientists that was presented in Pisa. One of them was presented by Dr. Prediletto. He had a very good presentation in Pisa. I do not know if those proceedings are easy to come by. But I think they will be published as papers sooner or later.

But this is a field that I would say is open for research if anyone has a good idea or a good ability to do it. The problem is how do you do studies in humans on this topic? It is very hard.

DR. HAMPSON: This is scanty breathing the last 24 h and it does not sound like pulmonary edema. My second question is has anyone ever documented endoscopically bleeding from the central airways? You showed the laryngeal view, but has anyone done bronchoscopy and seen tears on the tracheal membrane?

DR. LINDHOLM: There have been a few bronchoscopies done on divers, but these are done when the divers have gone to the hospital a week or two later after the incident. It is not something that are picked up on in the emergency room; that you might want to do a bronchoscopy or a lavage or something on a breath-hold diver. I do not think there are any reports except those from Boussuges from France on that issue.

I know that Kirk has some recommendations that he has worked out or they have worked out on bleedings.

MR. KRACK: Basically, if a person spits up and they have a little wisp of blood in their spit, then it is one week out of the water. When they get back in, it is 50% of the depth that they had the occurrence at and then day after day, just progressive working up. If they spit and there is more blood than there is spit, it is two weeks out of the water, again, 50%. Then just looking at the dive and figuring out what probably exacerbated the problem, looking up and stretching the trachea, that body positioning, contractions. I think I know who you are talking about. Cold would be another factor, and issues like that.

LARYNGOSPASM IN BREATH-HOLD DIVING

Christopher W. Dueker, MD

Professor Emeritus of Clinical Anesthesiology
Stanford University School of Medicine
Palo Alto, California, USA

Some breath-hold divers believe that laryngospasm (spastic glottic closure) will protect them from drowning. Conversely, laryngospasm has been proposed as a cause of fatal drowning. After decades of misunderstanding, it has been established that laryngospasm does not cause death from drowning. A protective effect of laryngospasm for breath-hold divers has neither experimental nor literature support.

The Larynx

The larynx separates the digestive tract from the trachea and lungs. Its small size belies its importance and complexity. The entrance to the larynx is guarded by the vocal cords (true and false) and the epiglottis (Figure 1).

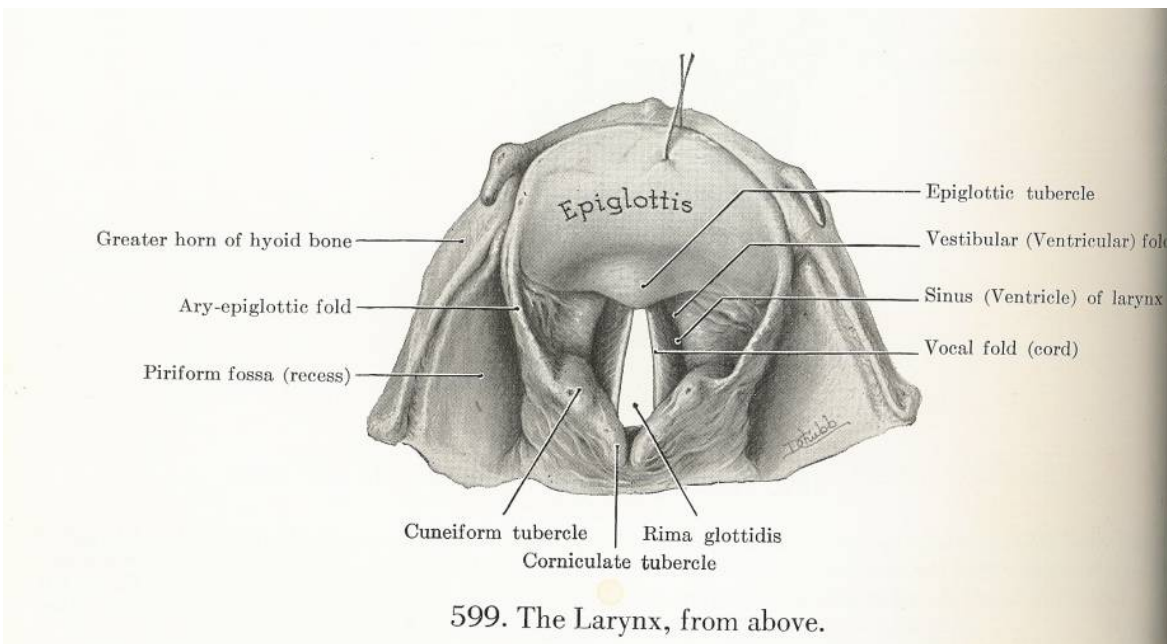

Figure 1: Anatomy of the larynx.

The main laryngeal functions are phonation and protection of the airway. Voluntary closure of the vocal cords assists in straining for weight lifting and defecation. Divers often close their vocal cords and exhale against a closed nose and mouth to equalize pressure in the middle ear (modified Valsalva maneuver).

The vocal cords reflexively close when food or secretions are near them. When a conscious person unexpectedly falls into water or is dunked in the surf, part of the defense mechanism will be reflex vocal cord closure. This is not laryngospasm.

Laryngospasm is a more complex process in which a 'ball valve' closure augments vocal cord closure (1). Laryngeal function and structure differs in humans compared to other animals (2). Experiments on animals such as dogs and cats study vocal cord closure which differs from human laryngospasm.

Laryngospasm protects the airway, but it also prevents gas exchange, and hypoxia develops. Ventilatory efforts against a closed glottis may cause pulmonary edema.

Clinical Laryngospasm

Laryngospasm is a complication of general anesthesia. Patients in the second stage of anesthesia (semiconscious), either during induction or emergence, may have spastic glottic closure in response to secretions or blood. Modern techniques usually eliminate the second state of anesthesia during induction. However, on emergence the larynx is very sensitive. At the level of surgical anesthesia the vocal cords are non-responsive.

During anesthetic laryngospasm, hypoxia quickly develops. Post-laryngospastic pulmonary edema is not uncommon, especially in vigorous patients who can develop profound negative intrathoracic pressures (3).

With deepening hypoxia the vocal cords will open. Laryngospasm does not lend itself to experimentation. The blood oxygen tension which relaxes spasm is unknown and probably variable.

Laryngospasm will not be fatal if oxygen is available to the patient when the spasm relaxes (4).

Authorities in otorhinolaryngology often write of human death from laryngospasm (5). These reports never offer evidence - experimental or from literature references.

Laryngospasm in Drowning

Drowning may be considered failed breath-holding. From the 1950s, some authors have claimed that 10% of fatal drownings occurred without water entering the lungs; i.e., that the victim dies from laryngospasm (6). This conflicted with the clinical observation that laryngospasm resolved before hypoxia was fatal.

The explanation proved to be quite simple. The belief in fatal drowning from laryngospasm was never valid. It was an untruth propagated for decades. The initial problem was a misquote, with the problem growing from there. The original paper, from 1931, was by a Frenchman named Cot who retrieved bodies from the Seine river (7). Cot talked about white people and blue people, not laryngospasm. Swann misquoted Cot's paper in 1947 (8). Figure 2 shows the growth of misunderstanding. Methods used to grow untruth included: misunderstanding references, misquoting references, failure to read references, self-referencing, circular referencing, use of invalid references, misuse of references, ignoring contrary references, failure to offer supporting references, and others. The strongest proponent of death from laryngospasm recounted his beliefs in 1999 (9). He later admitted that he had never read his primary reference since it was published in French (personal communication, JH Modell, 1999).

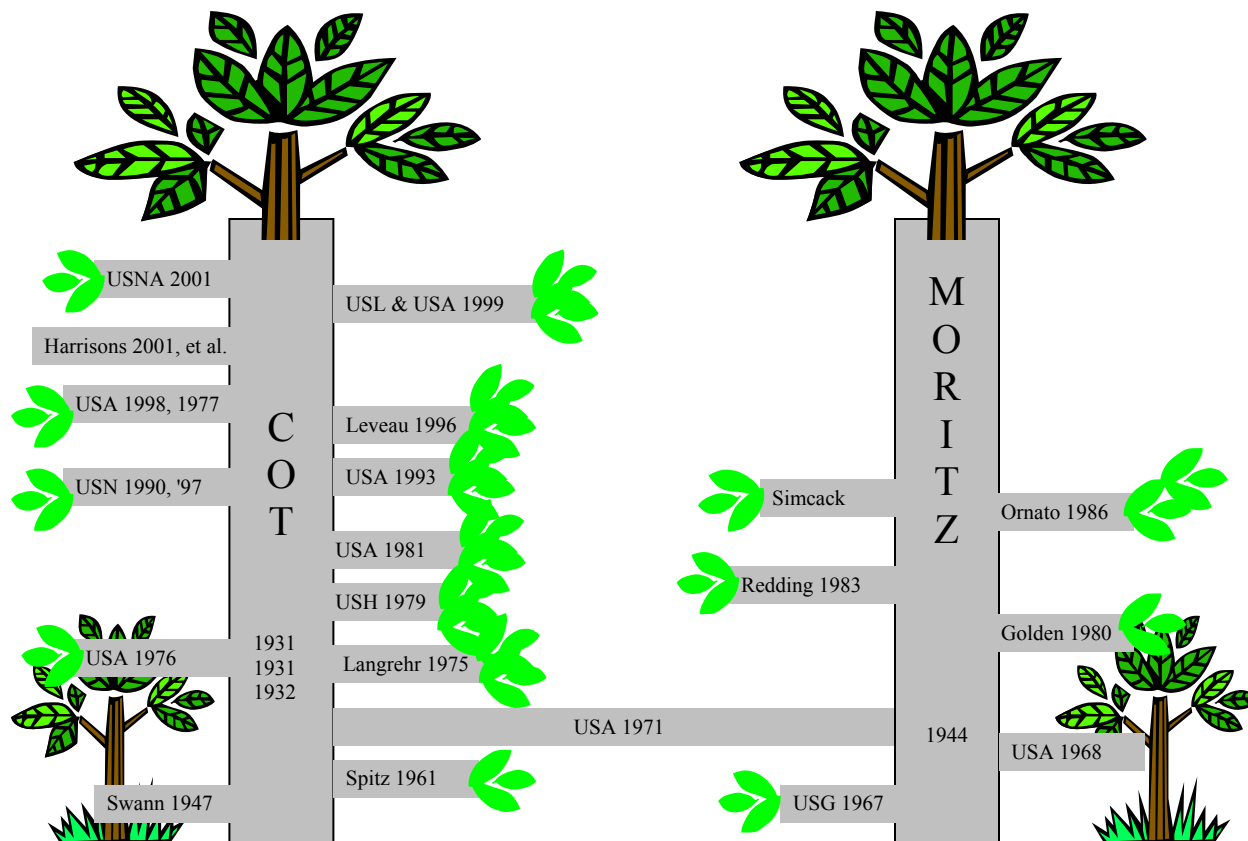

Figure 2: Apres Cot Tree.

Laryngeal Function in Breath-Holding

Vocal cord function has not been studied in breath-hold diving. One report noted a case of laryngospasm during a breath-hold competition (10). This was based on the presence of stridor, which does not establish the occurrence of true laryngospasm.

Vocal cord function during breath-hold was studied in a group of volunteers to evaluate protection in the airways of patients who had had partial laryngectomies (11). This surgery impairs the protection offered by the larynx during eating and drinking. A technique for a 'safe swallow' requires breath-holding during swallowing. Table 1 shows vocal cord closure during three types of breath-holding (11). Eighty-two percent of volunteers who held their breath by simply stopping breathing had vocal cord closure. Eighty-six percent of those who took a deep breath and performed a Valsalva maneuver had vocal cord closure. Only sixty-two percent of those taking a deep breath before apnea had vocal cord closure.

Table 1. Frequency of Vocal Cord Closure with Different Breath-Hold Strategies

Condition	Observed Closure (%)
Easy Breath-Hold	82
Inhale/Easy Breath-Hold	62
Hard Breath-Hold	86

Protection from Laryngospasm in Breath-Hold Diving

Vocal cord closure is certainly protective in the initial stages of an immersion accident. This occurs only when the victim is conscious. A person who is unconscious when they enter the water or who loses consciousness in the water will not have protective laryngeal reflexes.

If consciousness is lost during static apnea or in an underwater swimming contest, the vocal cords will relax and will not close in response to inhaled water.

Similarly a breath-hold diver who loses consciousness will not develop laryngospasm.

Laryngospasm could be briefly protective in a diver who is ascending but who has reached the break-point for breath-holding. Laryngospasm may keep water from the lungs. However, this protection is limited by the onset of hypoxia. Pulmonary edema may develop.

Breath-hold divers may develop distress upon surfacing. If they are semiconscious, laryngeal closure may protect their lungs until they can be assisted.

References

1. Fink BR. Etiology and treatment of laryngeal spasm. *Anesthesiology* 1986; 17(4): 569-577.
2. Fink BR. Evolution. In: Fink BR. *The Human Larynx*. New York: Raven Press, 1975: 16-30.
3. Willms D, Sure D. Pulmonary edema due to upper airway obstruction in adults. *Chest* 1988; 94(5): 1090-1092.
4. Olsson GL, Hallen B. Laryngospasm during anesthesia. A computer-aided incidence study in 136,929 patients. *Acta Anaesthesiol Scand* 1984; 28: 567-575.
5. Ikari T, Sasaki CT. Glottic closure reflex: control mechanisms. *Ann Otol* 1980; 89: 220-224.
6. Layton AV, Modell JH. Drowning and near drowning. In: Lundgren CEG, Miller JN, eds. *The lung at depth*. New York: Marcel Dekker. 1999: 395-415.
7. Cot C. *Les asphyxies accidentelles (submersion, electrocution, intoxication, oxycarbonique): etude clinique, therapeutique et preventive*. Paris: Maloine, 1931.
8. Swann HG, Brucer M, Moore C, Vezien BL. Fresh water and sea water drowning: a study of the terminal cardiac and biochemical events. *Tex Rep Biol Med* 1947; 5(4): 423-437.]
9. Modell JH et al. Drowning without aspiration: Is this an appropriate diagnosis. *U Forensic Sci* 1999; 44: 1119-1123.
10. Fitz-Clarke JR. Adverse events in competitive breath-hold diving. *Undersea Hyperb Med* 2006; 33(1): 55-62.
11. Donzelli J, Brady S. The effects of breath-holding on vocal cord adduction. *Arch Otolaryngol Head Neck Surg* 2004; 130(2): 206-210.

WORKSHOP DISCUSSION

DR. SCHAGATAY: I was curious when you said that there is no laryngospasm in cats and dogs, but you know there is one in primates except humans.

DR. DUEKER: In primates below humans, yes, that is probably true.

DR. SCHAGATAY: Do you have some evidence that it exists in all primates?

DR. DUEKER: I do not honestly know. I avoided that issue because I do not know. Dr. B.R. Fink in 1995 wrote me that to his knowledge true laryngospasm occurs only in humans.

DR. SCHAGATAY: It could be a difference between primates in diving because people dive and other primates do not.

DR. DUEKER: I am not arguing with you at all.

DR. SCHAGATAY: What about marine mammals?

DR. DUEKER: Excellent question regarding marine mammals. Then, the second part of my letter to Dr. Fink was, does anyone ever die from laryngospasm? He said no. He also suggested that one whale may have had a fatal blowhole spasm. That is all I know about marine mammals.

DR. SCHAGATAY: As far as I know, dry drowning is quite common in marine species.

DR. DUEKER: I doubt that that is true. One of the reasons I doubt that it is true, is that the laryngospasm death, if it occurred, would not be a dry drowning because you would have pulmonary edema. The absence or presence of water in the lungs does not prove that water had or had not been aspirated.

DR. FEINER: I enjoyed your talk. Quite entertaining. You should look up the Yogi Berra quote that goes something like, I never said half the things I said. I think that would go along very much with some of the mistakes.

Having dealt with laryngospasm many times, I think you are correct. All laryngospasm does stop. However, I think that we should talk about laryngospasm without complete glottic closure. We have a surgeon who loves to operate on the vocal cords, and you will for some time still be able to move air with a lot of closure. I think I would still call it laryngospasm even without complete glottic closure.

I think that although hypoxia eventually will stop laryngospasm, hypoxia is a little bit of a strange beast in that it can produce an anesthetic-like state, but there is a transition with release of a lot of excitatory neurotransmitters, predominantly glutamate. That is the source of a lot of the seizures. And I would suspect that that would produce a state where laryngospasm is possible very similar to Stage 2 of anesthesia because you do see excitatory phenomenon with loss of consciousness without the anesthetized patient. Under anesthesia with hypoxia, anesthetics significantly blunt that glutamate response in release of excitatory neurotransmitters. So, I think hypoxia under anesthesia we do not see that, and eventually you do see relaxation of the vocal cords.

[Anesthesia stages: 1 - between administration and loss of consciousness; 2 - state of excitation before full loss of consciousness; Stage 3 - deep, relaxed surgical anesthetic state].

DR. SMITH: One question is how much consciousness you have before the larynx closes. I had a relative in Kirk Krack's course develop shallow water blackout at 10 or 15 ft [3-5 m]. He looked fine until the moment he passed out. Kirk brought up him to the surface. He had no awareness when he woke up that he passed out. But if you did not have laryngospasm right then, why would you not on passing out just bubble air out of your mouth?

It seems like there is some mechanism, maybe it is not laryngospasm. Maybe it is something else. But when you pass out coming up with expanding lungs that you do not typically just blow all your air out. So if it is not laryngospasm, what is it, do you think?

DR. DUEKER: Well, I think that those people under those circumstances drown. And they get water in their lungs. And if they do not get a lot of water in their lungs, they survive, and you never know about it.

DR. SMITH: Maybe it is not laryngospasm. Maybe it is just epiglottic closure or something. I mean, these people see it all the time, people passing out coming up, and they do not blow all their air out and they hit the surface, wake up and finally take a breath. Maybe it is just epiglottic closure. I do not know.

DR. DUEKER: Well, the epiglottis, of course, does not close. It is a flap valve. But I really do not know. I will say that if you pass out coming up, chances are pretty good you are going to drown unless you follow the procedures that were admirably set out. And I really appreciated having those set out.

CARDIOVASCULAR AND HEMATOLOGICAL ADJUSTMENTS TO APNEIC DIVING IN HUMANS – Is the 'spleen-response' part of the diving response?

Erika Schagatay, PhD¹
Matt Richardson, MSc¹
Robert deBruijn, MSc¹
Johan PA Andersson, PhD²

¹ Department of Natural Sciences, Mid Sweden University, Sundsvall, Sweden

² Department of Cell and Organism Biology, Lund University, Lund, Sweden

Abstract

Adaptive mechanisms, involving both the cardiovascular diving response and the red blood cell boosting spleen contraction may serve to facilitate apneic diving in humans. Both mechanisms have been shown to have apnea-prolonging effects. The more recently discovered spleen response may or may not be part of the general cardiovascular diving response, which will be discussed based on published and new data. Methods used were mainly simulated apneic diving by serial apneas or apneas with facial immersion, spaced by short pauses, with the registration of cardiorespiratory and haematological parameters. The volunteer participants were healthy untrained subjects and divers of various levels of training. We found that the hematological response was not fortified by facial chilling by immersion like the cardiovascular diving response, but appears to be triggered by the apnea stimulus alone, possibly in part by the hypoxic stimulus. While the diving response reaches its full magnitude during each subsequent apnea with full recovery between apneas, the hematological response developed progressively across several apneas, and is not fully reversed until at least 10 min after apneas. Taken together the results suggest that the hematological response may be closely associated with, but not neurally linked to the human diving response, indicating that there are two different responses associated with human apneic diving. The main functions of the two adjustments may also be different: While the cardiovascular diving response has an oxygen-conserving effect during apnea, the blood boosting spleen contraction will increase blood gas storage capacity, increasing dive oxygen storage as well as buffering capacity, and may also exert an important effect by facilitating recovery between apneas.

Introduction

Cessation of breathing (apnea), whether voluntary or involuntary, is one of the most acute stress-situations for the organism, which can within short become a threat to survival. This raises great demands on an effective regulation of limited supplies of oxygen in lungs, blood and other tissues, and any increase of the gas-storage potential would also be beneficial. Functions known to serve these regulatory purposes in diving mammals are the cardiovascular diving response and the red blood cell boosting spleen contraction, which may facilitate apnea and apneic diving also in humans. Previous studies revealed the presence of an oxygen-conserving diving response also in humans, and more recently a hematological response from spleen contraction was described.

Diving response

The diving response, first observed in human divers by Irving (12) can be viewed as a priority system triggered during the threat of apneic asphyxia (hypoxia, hypercapnia and acidosis). The most pronounced physiological adjustments are a reduction of the heart rate (bradycardia) and selective vasoconstriction. The function is to guarantee the oxygen supply to the heart and brain (7), which cannot survive without a constant access to oxygen, while less sensitive organs rely on stored oxygen (e.g., myoglobin in muscles), anaerobic metabolism, or, possibly, hypometabolism. Physiological mechanisms for reducing metabolism during apnea are selective vasoconstriction, causing local reduction in oxygen consumption and the bradycardia in itself, leading to a reduction of the demand of oxygen of the cardiac muscle (15). Both mechanisms have been considered to contribute to prolonged apneic durations in diving mammals (7). It has previously been shown that these factors are at work with a dive-prolonging (19) and oxygen-conserving effect also in humans during apnea (1) and during apnea with exercise (2,3,16).

Spleen response

In diving seals, spleen contraction has been shown to contribute to prolonged apneas by release of erythrocytes (11,17). Spleen contraction has been observed in humans both during physical exercise (14) and diving (10). Hurford observed a decrease in spleen size after long series of breath-hold dives in the Korean Ama by measurements with ultrasonic imaging (10). Little is known about its initiation and function, but the response appears to develop across a number of apneas. In both diving mammals and naturally diving humans, dives are performed in series with the duration of apneas and surface intervals adapted to the working depth. In elite apneists, 'workup' apneas are used to increase performance, and may yield apneic durations exceeding eight minutes. Repeated apneas with short (<10 min) intervals have been shown to prolong human apneic time (9). The underlying mechanisms were poorly understood until it was discovered that the hemoglobin concentration (Hb) and hematocrit (Hct) were reversibly increased over series of apneas and not accompanied by an increase in plasma proteins, which suggests that spleen contraction had occurred (22). The conclusion was supported by a lack of this response in splenectomized subjects (subjects with spleen removed), which also lacked the increase in apneic time observed in the subjects with spleen (22). A close association was observed between changes in spleen size and Hct and Hb across a series of apneas, which supports the conclusion that spleen contraction is the origin of the hematological effects (18). This indicates that the spleen response can be held responsible for an increase in apneic time at repeated apneas in humans (22).

It seems clear that both the cardiovascular diving response and the spleen response have potentially dive-prolonging effects in diving mammals as well as in humans. Repeated diving may elicit the diving response and spleen contraction at similar or different time frames, by the same or by different mechanisms. If mechanisms for initiation and time for establishment of the adjustments are similar or identical, they could be considered parts of the same general response, and we have to accept a wider definition than the classical of the diving response. But if initiation and development are different, they may be two different responses occurring in parallel but with different physiological origins. The aim is to further study the mechanisms responsible for initiation of the responses and their development, to reveal whether the spleen-response is part of the classical diving response.

Methods

A model for 'simulated diving' by apnea or apnea with facial immersion in cold water has been developed in our laboratory, allowing a high level of control of the behavioral and environmental factors which can affect the associated responses (20). Healthy adult volunteers of both sexes, with

categorized diving experience and physical-training background, participated. They performed series of apneas, simulated dives or immersed dives, at rest or during exercise, usually with short (2 min) recovery pauses. Apneas were typically performed after a deep but not maximal inspiration, and preceded by normal respiration. Durations and details in performance depended on the factor being studied. By manipulating the factor of interest we could elucidate the physiological mechanisms responsible for the cardiorespiratory or haematological adjustments. The method developed is based on continuous registration of cardiovascular and respiratory parameters using mainly non-invasive techniques. These methods are combined with the use of invasive techniques, mainly blood sampling and ultrasonic imaging for measurements of spleen size. As a complement to the simulated diving model we have in some studies used field registrations from divers, or experiments in an indoor tank. For details in methods see previous studies and below.

Results and Discussion

Initiation and development of the cardiovascular diving response

The main neural inputs eliciting the cardiovascular diving response are 1) initiation of apnea, most likely mediated via lung stretch receptors, or possibly by direct radiation from the respiratory center to the cardiovascular control centers (7), and 2) chilling of the face (13), mediated by cold receptors in the upper part of the face (24). About half of the response is present at apnea alone, compared to apnea with face immersion (Figure 1). The influence of hypoxia and hypercapnia appear to be of minor importance. The diving response is thereby a preventive system, as the response is triggered prior to the occurrence of asphyxia. The diving response develops rapidly upon apnea onset, and is fully developed within 30 s (Figure 3). The recovery after apnea is also nearly immediate, and the diving response does not change in magnitude across serial apneas or dives (21; Figure 3). The response is, however, affected by the intensity of the thermal stimulus, i.e., the difference between ambient air and water temperatures (20). It was concluded from that study that the tropical diver will also have a well developed response, as long as there is a temperature difference between air and water. A more recent study revealed that an oxygen conserving diving response resulted with apneic face immersion also in the diver with the body being constantly immersed in 23°C water, despite cold induced vasoconstriction and other circulatory effects of the immersion (6). The diving response was also found to dominate over the tachycardia response normally associated with immersion of the arm, when both arm and face were immersed in cold water during apnea (4). It is present also during exercise and apnea (2,3). This powerful response thus seems to have the highest priority in cardiovascular regulation, overruling the influence of other strong cardioregulatory stimuli.

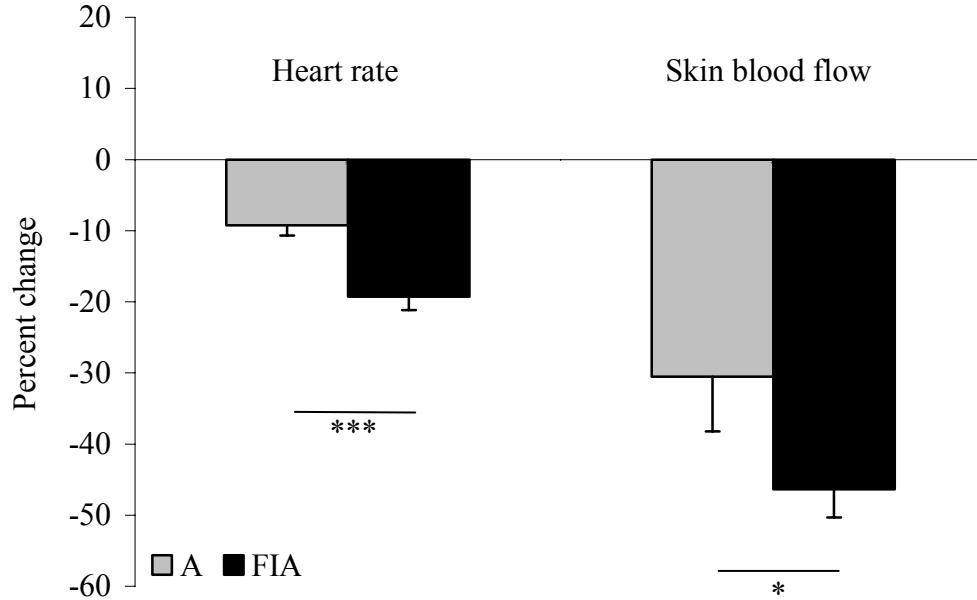

Figure 1. Mean (\pm SE) heart rate and skin blood flow reduction during apneas (A) and apneas with face immersion (FIA) of the same duration in eight subjects. Significance is indicated by *, for $p < 0.05$, and *** for $p < 0.001$.

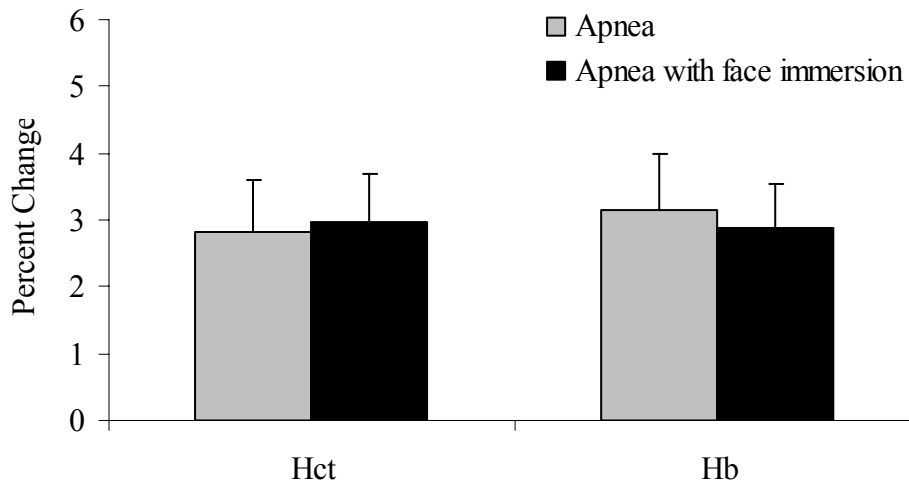

Figure 2. Mean (\pm SE) change in hematocrit (Hct) and hemoglobin concentration (Hb) from eight subjects during apneas (A) and apneas with face immersion (FIA) of the same duration. No differences were observed between A and FIA.

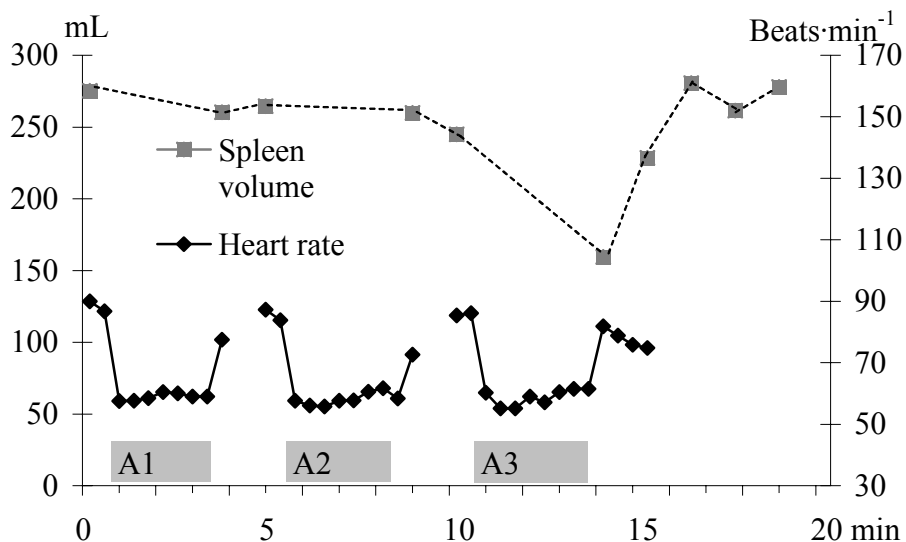

Figure 3. Spleen volume (mL) and heart rate (beats·min⁻¹) values from one subject across three maximal effort apneas (A1-A3) performed in series interspaced by 2 min pauses. Spleen volume is calculated from three diameters, measured using ultrasonic imaging.

Initiation and development of spleen contraction and hematological response

Spleen contraction and the associated increases in Hct and Hb appear to develop slowly compared to the cardiovascular diving response, and several apneas are required for the full response development (22; Figure 3). The hematological response has been suggested to be initiated by apnea and facial immersion, i.e., by the same factors as the cardiovascular diving response (8). However, we found that the response was the same irrespective of face immersion in cold water or not (Figure 2). It appears that apneic hypoxia augments the response, but some of the Hb response occurs also during normoxic apnea (18), indicating that hypercapnia or the apnea in itself may also be involved. There are indications that catecholamines are involved in inducing the exercise-related spleen contraction, but also that these hormones do not account for all of the changes seen (25). The conclusions from different studies concerning recovery have been very different, likely depending on both the method used for triggering the response and for detecting the spleen volume changes. The recovery process has been described to be completed within 2 min after apneas when apneas were spaced by at least 10 min of rest (8). This contrasts to the findings by Bakovic and associates (5) where the recovery lasted at least 60 min after serial apneas. Our studies using five apneas spaced by 2 min, suggest an intermediate recovery time, of approximately 10 min after the last apnea (23). However, when we used several such apnea series spaced by 10 min, the recovery was still incomplete after 10 min between series but complete 10 min after the last series (unpublished observations). Further studies will reveal the physiological origin of spleen contraction, but it seems clear that the mechanisms are different from those initiating the diving response.

Conclusions

These results suggest that the hematological spleen response is not neurally linked with the human diving response, nor is it developing in the same time span. The different initiation and development

indicate that the diving response and the spleen response should be viewed as two different responses associated with human apneic diving, each with specific effects on apneic performance.

Acknowledgments

We want to express our sincere gratitude to the subjects participating in all of our breath-holding experiments and to all co-authors and sponsors of previous work.

References

1. Andersson J, Schagatay E. Arterial oxygen desaturation during apnea in humans. *Undersea Hyperb Med* 1998; 25: 21-25.
2. Andersson, JPA., Linér MH, Rünow E, Schagatay E. Diving response and arterial oxygen saturation during apnea and exercise in breath-hold divers. *J Appl Physiol* 2002; 93: 882-886.
3. Andersson J, Linér M, Fredsted A, and Schagatay E. Cardiovascular and respiratory responses to apneas with and without face immersion in exercising humans. *J Appl Physiol* 2004; 96: 1005-1010.
4. Andersson J, Schagatay E, Gislén A, Holm B Cardiovascular responses to cold water immersions of the forearm and face, and their relationship to apnoea. *Eur J Appl Physiol* 2000; 83: 566-572.
5. Bakovic D, Valic Z, Eterovic D, Vukovic I, Obad A, Marinovic-Terzic I, and Dujic Z. Spleen volume and blood flow response to repeated breath-hold apneas. *J Appl Physiol* 2003; 95: 1460-1466.
6. DeBruijn R, Richardson M, Schagatay E. The function of the human diving response in the immersed diver. Abstract. *Eur Underwater and Baromed Soc (EUBS) meeting Copenhagen, Denmark August 2003: 27-31.*
7. Elsner R, Gooden B. *Diving and asphyxia: A comparative study of animals and man.* Physiological Society Monograph 40. Cambridge Univ Press, Cambridge, 1983; 175 pp.
8. Espersen K, Frandsen H, Lorentzen T, Kanstrup I-L, and Christensen N J. The human spleen as an erythrocyte reservoir in diving related interventions. *J Appl Physiol* 2002; 92: 2071-2079.
9. Heath JR, Irvin CJ. An increase in breath-hold time appearing after breath holding. *Resp Physiol* 1968; 4:73-77.
10. Hurford WE, Hong SK, Park YS, Ahn DW, Shiraki K, Mohri M, Zapol WM. Splenic contraction during breath-hold diving in the Korean ama. *J Appl Physiol* 1990; 69: 932-936.
11. Hurford WE, Hochachka PW, Schneider RC, Guyton GP, Stanek KS, Zapol DG, Liggins GC, Zapol WM. Splenic contraction, catecholamine release, and blood volume redistribution during diving in the Weddell seal. *J Appl Physiol* 1996; 80:298-306.
12. Irving L. Bradycardia in human divers. *J Appl Physiol* 1963; 18: 489-491.

13. Kawakami Y, Natelson BH, DuBois AB. Cardiovascular effects of face immersion and factors affecting the diving reflex in man. *J Appl Physiol* 1967; 23: 964-970.
14. Laub M, Hvid-Jacobsen K, Hovind P, Kanstrup IL, Christensen NJ, and Nielsen SL. Spleen emptying and venous hematocrit in humans during exercise. *J Appl Physiol* 1993; 74: 1024-1026.
15. Lin YC. Breath-hold diving in terrestrial mammals. *Exercise and Sports Sci Rev* 1982; 10, 270-307.
16. Lindholm P and Linnarsson D. Pulmonary gas exchange during apnoea in exercising men. *Eur J Appl Physiol* 2002; 86: 487-491.
17. Qvist J, Hill RD, Schneider RC, Falke KJ, Liggins GC, Guppy M, Elliot RL, Hochachka PW, Zapol WM. Hemoglobin concentrations and blood gas tensions of free-diving Weddell seals. *J Appl Physiol* 1986; 61: 1560-1569.
18. Richardsson M, deBruijn R, Schagatay E. Hypoxia – a trigger for spleen contraction? Abstract at the 31st annual meeting of EUBS and XVmeeting of ICHM, Barcelona, Spain. September 2005: 7-10.
19. Schagatay E, Andersson J. Diving response and apneic time in humans. *Undersea & Hyperbaric Med* 1998; 25: 13-19.
20. Schagatay E, Holm B. The effects of water and ambient air temperatures on human diving bradycardia. *Eur J Appl Occup Physiol* 1996; 73: 1-6.
21. Schagatay E, van Kampen M, and Andersson J. Effects of repeated apneas on apneic time and diving response in non-divers. *Undersea Hyperb Med* 1999; 26: 143-149.
22. Schagatay E, Andersson J, Hallén M, Pålsson B. Selected contribution: role of spleen emptying in prolonging apneas in humans. *J Appl Physiol* 2001; 90: 1623-1629.
23. Schagatay E, Haughey H, Reimers J. Speed of spleen volume changes evoked by serial apneas. *Eur J Appl Physiol* 2005; 93: 447-452.
24. Schuitema E, Holm B. The role of different facial areas in eliciting human diving bradycardia. *Acta Physiol Scand* 1988; 132: 119-120.
25. Stewart IB, Warburton DE, Hodges AN, Lyster DM, McKenzie DC. Cardiovascular and splenic responses to exercise in humans. *J Appl Physiol* 2003; 94: 1619-1626.

WORKSHOP DISCUSSION

DR. SHANK: Neonates and infants do have quite a dramatic response. You showed pictures of these Indonesian children swimming. Have you tested diving responses on them? Do they have stronger diving responses?

DR. SCHAGATAY: I have not had the opportunity to test Indonesian children, but a master student in my laboratory, Ulrica Milling, is doing tests now on Swedish children during their first year of life. The diving response appears to be stronger during the first half year of life. Also the apnea response is greater during this period, which is the reflex protecting you from aspirating water when you are a newborn. The apnea response is different than the diving response, but the two are connected. During early life the apnea is automatic and together with face immersion it initiates the diving response. During the rest of our lives we have to perform apnea voluntarily. During the first six months both of these responses appear to be stronger than the other six months up to one year of age. But it would be interesting to study the Indonesian children and compare them to untrained children.

DR. FOTHERGILL: Do you have any plans to look at training high and living high on breath-hold? And opening up to the competitive breath-holders, do they already do that before they do competitions?

DR. SCHAGATAY: We were working a little bit with other sports people, like skiers, for instance, and cyclists. And we think, on the contrary, that these athletes may actually benefit from doing apnea instead of going to high altitude. Because in high altitude training you have a high risk of infection and not being able to train as well as in a low altitude. But what if apnea is the key to getting the same changes as high altitude? We are doing some high-altitude studies now, as a part of the doctoral work of graduate student Robert deBruijn, to compare in the same individuals the responses between high-altitude stimulation and apnea. So it is a very relevant connection.

DR. LUNDGREN: There are some fundamental differences between the physiology going to depth and lying prone in the dry lab with your face in cold water. And we will get back to that, but I hold that the blood pressure increase that we saw in people diving to 50 m [164 ft] of depth might be quite different from the change you see in blood pressure or the absence thereof when you take a breath without any lung volume reduction.

CORRELATION BETWEEN SPLEEN SIZE AND HEMATOCRIT DURING APNEA IN HUMANS

Matt Richardson, MSc¹
Robert de Bruijn, MSc¹
Sofia Petterson, PhD¹
Jenny Reimers, MD²
Erika Schagatay, PhD¹

¹ Department of Natural Sciences, Mid Sweden University, Sundsvall, Sweden

² X-ray Clinic, Härnösand Hospital, Härnösand, Sweden

Introduction

Increases in hemoglobin concentration (Hb) and hematocrit (Hct) have been observed after both solitary (3) and repeated apneas spaced by short intervals (2,7). In the latter case, the increase in Hb and Hct reaches a maximum after 3–4 maximal effort apneas (7). This increase is reversed within 8–9 min after cessation of apneas (8). The return to baseline of Hb shows that the response is not due to increased diuresis or sweating, and constancy of protein levels shows that it is not due to extravasation of plasma by increased filtration (7). In diving mammals, such as seals, increases in Hb and Hct have also been observed during dives and this has been attributed to a simultaneous reduction in spleen size (4). It is thus conceivable that the increase in Hb and Hct seen during apneas in humans is, at least partly, caused by a similar contraction of the spleen. In humans, as in other mammals, the spleen apparently retains erythrocytes and forms a reservoir of red blood cells while reducing blood viscosity during rest (10), but the size of this reservoir still needs to be determined. Contraction of the spleen during apnea has been shown to be an active process, largely independent of arterial inflow, suggesting the presence of a centrally-mediated feed-forward mechanism (1). No direct assessment has been made of splenic volume changes in relation to increases in hematocrit during apnea, and the indirect estimations have varied. In this study we aimed to further investigate the relation between spleen volume, Hb and Hct during serial apneas.

Methods

Four healthy subjects volunteered to perform a series of three maximal apneas, spaced by two minute pauses. Ultrasonic measurements of spleen diameter and venous blood samples, for Hb and Hct analysis, were taken pre-series, after the 1st and 3rd apnea, and at 2, 4, 6, 8, and 10 min following apnea 3. Ultrasonic measurements of spleen maximal length (L), thickness (T) and dorsoventral width (W) were used to calculate spleen volume using the following equation: $L\pi(WT-T^2)/3$. Comparisons between pre- and post-series measurements were made for splenic volume, Hb and Hct using paired Students t-test. Correlations between spleen volume and Hb and Hct across the series were calculated using Pearsons test. An estimation of the spleen contribution to observed Hct changes was made, based on an estimated blood volume of 8% of body weight, a spleen hematocrit of 80% (5) and the spleen volume and Hct observed before and after apneas.

Results

A reduction in spleen volume during apneas was seen in all subjects, on average from 338 mL pre-series to 223 mL directly after apnea 3 (by 34%; $p=0.01$). Simultaneous increases in Hb, from $133 \text{ g}\cdot\text{L}^{-1}$ to $136 \text{ g}\cdot\text{L}^{-1}$ ($p=0.02$), and in Hct, from 38.6% to 39.9% ($p=0.07$), were observed (Figure 1). The Pearson's correlation coefficients for spleen volume and Hb and Hct were -0.88 and -0.85, respectively (both $p<0.01$). The reduction in spleen volume was estimated to account for 70% of the observed increase in Hct. The apnea-induced changes of Hb, Hct and spleen volume were completely reversed within 10 min after the last apnea.

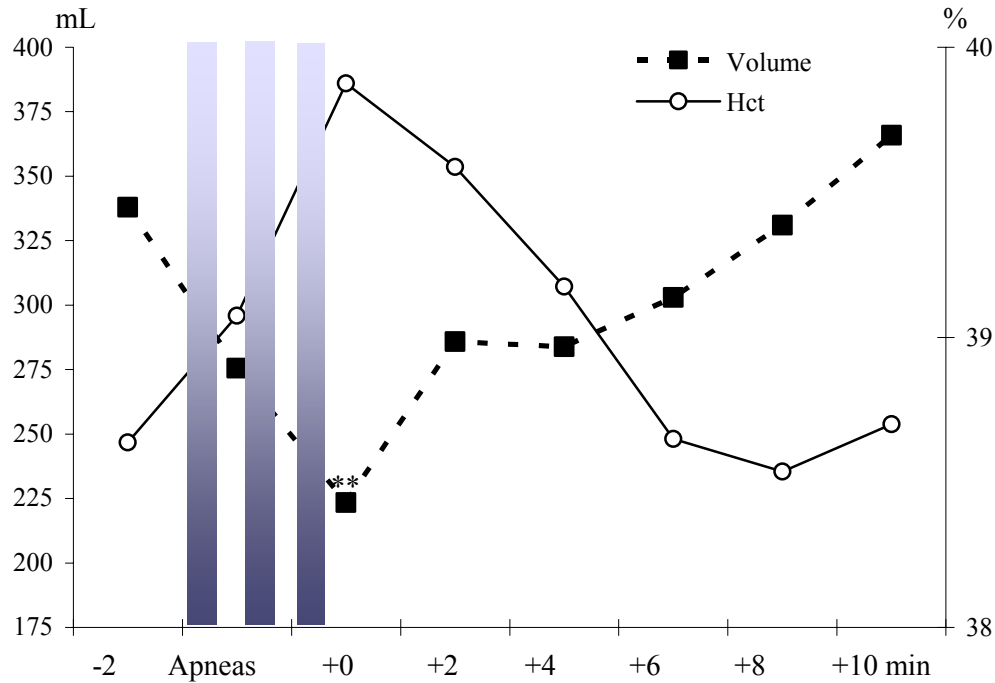

Figure 1. Mean spleen volume (mL) and hematocrit (Hct: %) from four subjects before apneas, after apnea 1, apnea 3, and during 10 min recovery after apneas. ** denotes significance at $p<0.01$ for spleen volume after apneas, compared to control. The p value for Hct was 0.07.

Discussion

The inverse correlation between spleen volume and both Hb and Hct during the apnea series suggests a causative relation between the parameters. The estimation that the observed reduction in spleen volume could account for 70% of the observed Hct increase, further supports this conclusion. This is a higher value compared to previously reported estimations of 60% (7) and 37% (8). One difference may be the timing of post apnea spleen volume measurement, which in the present study is directly after apnea termination. We speculate that the remaining increase in Hb and Hct could arise from either extravasation of plasma, or possibly from venous blood pools with high hematocrit in the abdomen such as the liver. The transient increases in circulating erythrocyte volume will increase oxygen storage capacity as well as carbon dioxide buffering during subsequent apneas, both with a dive prolonging effect. The spleen related increases in Hb and Hct may be an explanation for the increases in apneic duration in successive apneas (7), previously thought to be due to

hyperventilation. Some observations indicate that this spleen and Hb response may be trainable: The increase in apneic duration across serial apneas tended to be stronger after apnea training (9), and trained apneists were found to have a larger increase in Hb during apneas, compared to untrained subjects and elite cross-country skiers (6), which is linked to spleen contraction by the present study. Further studies will reveal whether the spleen response can be trained, and what benefits it may offer in different sports.

Conclusion

We conclude that spleen contraction and Hb and Hct changes develop in close association and that the main cause of the rise in Hb and Hct observed after repeated apneas is spleen contraction.

References

1. Bakovic D, Eterovic D, Saratlija-Novakovic Z, Palada I, Valic Z, Bilopavlovic N, Dujic Z. Effect of human splenic contraction on variation in circulating blood cell counts. *Clin Exp Pharmacol Physiol* 2005; 32: 944-951.
2. Bakovic D, Valic Z, Eterovic D, Vukovic I, Obad A, Marinovic-Terzic I, Dujic Z. Spleen volume and blood flow response to repeated breath-hold apneas. *J Appl Physiol* 2003; 95: 1460-1466.
3. Espersen K, Frandsen H, Lorentzen T, Kanstrup IL, Christensen NJ. The human spleen as an erythrocyte reservoir in diving-related interventions. *J Appl Physiol* 2002; 92: 2071-2079.
4. Hurford WE, Hochachka PW, Schneider RC, Guyton GP, Stanek KS, Zapol DG, Liggins GC, Zapol WM. Splenic contraction, catecholamine release, and blood volume redistribution during diving in the Weddell seal. *J Appl Physiol* 1996; 80: 298-306.
5. Laub M, Hvid-Jacobsen K, Hovind P, Kanstrup IL, Christensen NJ, Nielsen SL. Spleen emptying and venous hematocrit in humans during exercise. *J Appl Physiol* 1993; 74: 1024-1026.
6. Richardson M, de Bruijn R, Holmberg H-C, Björklund G, Haughey H, Schagatay E. Increase of hemoglobin concentration after maximal apneas in divers, skiers, and untrained humans. *Can J Appl Physiol* 2005; 30: 276-281.
7. Schagatay E, Andersson JP, Hallen M, Palsson B. Selected contribution: role of spleen emptying in prolonging apneas in humans. *J Appl Physiol* 2001; 90: 1623-1629,1606.
8. Schagatay E, Haughey H, Reimers J. Speed of spleen volume changes evoked by serial apneas. *Eur J Appl Physiol* 2005; 93: 447-452.
9. Schagatay E, van Kampen M, Emanuelsson S, Holm B. Effects of physical and apnea training on apneic time and the diving response in humans. *Eur J Appl Physiol* 2000; 82: 161-169.
10. Stewart IB, McKenzie DC. The human spleen during physiological stress. *Sports Med* 2002; 32: 361-369.

WORKSHOP DISCUSSION

None.

DECOMPRESSION SICKNESS IN BREATH-HOLD DIVING

Robert M. Wong, MB, FANZCA

Department of Diving & Hyperbaric Medicine, Fremantle Hospital, Fremantle,
Western Australia 6160, Australia

Introduction

Breath-hold (BH) diving is common among recreational divers, seafood harvesters, hitherto pearl and sponge divers, and nowadays, competitive breath-hold sports divers. Although risks of breath-hold diving such as barotraumas, salt water aspiration, near drowning and drowning syndrome, hypothermia, cardiac arrhythmias, marine animal injuries and 'shallow water blackout' or ascent hypoxia are well known and acknowledged, neurological problems caused by decompression sickness (DCS) in BH diving is seldom described. It has long been held that bubble formation causing DCS from BH diving is most unlikely. Nevertheless, in 1931, Professor Gito Teruoka asserted in his article *Die Ama und ihre Arbeit* (1) that he was aware of the increased nitrogen uptake with increased ambient pressure, but could not find any confirmed cases of DCS among the Ama divers. He indicated then that further research was necessary. Since before the advent of the ultra sound Doppler detector, Schaefer (2) observed foam in venous and arterial blood drawn immediately after a BH diver surfaced from a single dive, lasting one and a half min to 89 feet of sea water (fsw) (27 metres of sea water [msw]). Subsequent samples drawn 10 s after surfacing did not show any bubbles, indicating their transient nature. Over 10 years later, Spencer and Okino (3) and Nashimoto (4) detected venous gas emboli following repeated BH dives in Ama divers. Nitrogen accumulation measured in brachial venous blood has also been demonstrated in repetitive BH diving in Korean Ama divers, but it was thought that the level of nitrogen accumulation was insufficient to cause DCS (5). The dives however lasted only three hours and to depths of 13 fsw (4 msw). Further attempts to identify bubbles in BH divers were made, Boussuges et al. (6) using continuous Doppler and 2D echocardiography did not find evidence of circulating air bubbles in BH divers who dived to depths of 79-131 fsw (24-40 msw) over a two to six hour period. The tests were performed within 30 min of the last dive of the day (range 3-75 min). Bubbles present during unmonitored periods would have been missed.

History

Cross (7) described *Taravana*, a condition known in Tuamotu Archipelago in French Polynesia where the BH pearl divers suffered symptoms such as vertigo, paralysis, mental anguish and unconsciousness (Table 1). They dived to depths of between 43-141 fsw (13-43 msw) with BH time of up to two-and-one-half minutes and surface intervals of between four to 10 min, usually working a six hour day. Cross stated that "Taravana is most frequent toward the end of the day of diving when divers working in rich lagoon under ideal conditions go crazy with greed and dive until the shell is gone or Taravana strikes." However, in a nearby lagoon Mangareva, divers had 12 to 15 min surface intervals and never suffered from Taravana..

Table 1: Taravana symptoms recorded by Cross (7) in a six hour working day of 47 divers

Symptom	Count	Percentage
Vertigo	34/47	72.3
Nausea	34/47	72.3
Mental anguish	34/47	72.3
Paralysis – partial/complete	6/47	12.8
Temporary unconsciousness	3/47	6.4
Mentally affected	2/47	4.3
Death	2/47	4.3

Reported Cases

Paulev (8) experienced symptoms of DCS such as nausea, dizziness and belching, followed by onset of pain in his hip and knee after performing repetitive BH dives to 66 fsw (20 msw) for five hours. He also suffered a weak left arm and tired right arm, as well as paresthesia and blurring of vision. However, his dives were preceded by a hyperbaric exposure as a chamber attendant for eight minutes at 66 fsw (20 msw). Three similar cases of DCS in BH divers were reported, after they were exposed to pressure in a hyperbaric chamber prior to BH diving.

Bayne and Wurzbacher (9) and Bruch (10) have described cases of pulmonary barotrauma in BH divers who were at depths of 6-15 fsw (1.8-4.5 msw), respectively.

Fanton et al. (11) reported the case of a spearfisherman who performed 14 repetitive dives per hour for three hours to depths of up to 131 fsw (40 msw). He lost consciousness on surfacing without any evidence of near drowning. Investigation showed abnormal electroencephalogram (EEG) and magnetic resonance imaging (MRI) findings consistent with focal neurological damage.

Kohshi et al. (12) reported multiple cerebral infarctions in two Japanese Ama divers who dived repeatedly between 49 and 82 fsw (15 and 25 msw) for five hours. Subsequent publications (13,14) discussed 16 Ama divers, 13 of whom had neurological dysfunction (Table 2).

Table 2: Symptoms of 16 Japanese Ama divers reported by Kohshi et al. (12)

Symptom	Count	Percentage
Dizziness	9/16	56.3
Hemiparesis	6/16	37.5
Nausea	6/16	37.5
Euphoria	4/16	25.0
Sensory numbness	3/16	18.7
Dysarthria	1/16	6.3
Loss of consciousness	1/16	6.3
No symptoms	3/16	18.8

Neurological problems have also been reported in competitive sports diving - in multiple unassisted dives 82-98 fsw (25-30 msw); three assisted dives 115-295 fsw (35-90 msw) and a single weight and buoyancy assisted dive to 394 fsw (120 msw) (15). These divers suffered from such symptoms as hemiplegia, ataxia, dysarthria, diplopia and color blindness. The diver who made a single dive to 394

fsw (120 msw) had reached that depth several times previously without problems. On this occasion, however, he used a new assisted ascent technique (at $13 \text{ ft}\cdot\text{s}^{-1}$ or $4 \text{ m}\cdot\text{s}^{-1}$). Shortly after surfacing, he experienced paresthesia in the right leg, followed within minutes by a right-sided hemiplegia which responded to treatment within 30 min of a USN Treatment Table (16).

A large number of Spanish spearfishermen using submarine scooters have suffered neurological symptoms. They have managed to achieve depths of between 82 –151 fsw (25 to 46 msw), with BH time of up to four minutes (90-240 s; mean 2:13 min:s) (17) (Table 3). A depth of 207 fsw (63 msw) has also been reported – the number of dives varied from 15 to 20 dives per hour over a period of three to eight hours. The surface interval was usually two minutes or less. Symptoms were immediate on surfacing and were all neurological (18).

Table 3: Symptoms of 30 Spanish breath-hold divers (18)

Symptom	Count	Percentage
Paresthesia	17/30	56.7
Altered level of consciousness	13/30	43.3
Headache	13/30	43.3
Muscular weakness	11/30	36.7
Visual disturbance	10/30	33.3
Fatigue	7/30	23.3
Speech disturbance	7/30	23.3
Dizziness/vertigo	5/30	16.7
Motor incoordination	5/30	16.7
Memory loss	4/30	13.3
Agitation	2/30	6.7
Convulsion	1/30	3.3
Sphincter relaxation	1/30	3.3
Auditory disturbance	1/30	3.3
Cardiorespiratory arrest	1/30	3.3
Vomiting	1/30	3.3
Localized pain	1/30	3.3

In Australia, spearfishing is popular among BH divers. A preliminary survey (19) and yet unpublished data indicated that very few who suffered symptoms consulted their medical practitioners. This is due mainly to the lack of appreciation that DCS could occur in BH diving and also that such symptoms (Table 4) are usually attributed by the divers to other causes such as viral illness; furthermore, such symptoms are normally of short duration, and mostly no sequelae are experienced.

Table 4: Symptoms of eight Australian spearfishermen (19)

Symptom	Count	Percentage
Headache	4/8	50.0
Nausea	4/8	50.0
Dizziness/vertigo	4/8	50.0
Lacks concentration	3/8	37.5
Fatigue/lethargy	3/8	37.5
Visual disturbance	2/8	25.0
Lacks coordination	2/8	25.0
Disorientation	1/8	12.5
Speech disturbance	1/8	12.5
Vomit	1/8	12.5
Paresthesia	1/8	12.5
Joint pain	1/8	12.5

Symptoms

Symptoms encountered among different groups of BH divers include dizziness, ataxia, nausea, hemiparesis, hemi-sensory numbness, paresthesia, headache, inability to concentrate, visual, auditory and speech disturbances, euphoria, muscular weakness as well as disorientation and altered state of consciousness, and some less common symptoms such as memory loss, agitation, convulsion, fatigue, sphincter relaxation, joint pain and cardiorespiratory arrest (Table 5). Symptoms common in scuba divers such as musculoskeletal pains and spinal cord involvement are uncommon in BH divers – only one case each was noted in the Australian BH divers (two days after the event), one Spanish recreational diver and those who have had previous hyperbaric (chamber) exposure prior to BH diving. Lesions, particularly in the Japanese Ama divers, tend to be centrally located with sparing of the spinal cord or musculoskeletal systems (14). Some of the symptoms described by BH divers could have been due to nitrogen narcosis (such as euphoria), hypoxia (altered level of consciousness, muscular weakness and incoordination, visual disturbance), carbon dioxide retention (headache, dizziness, confusion and amnesia) or even middle/inner ear barotraumas (vertigo, nausea, disorientation, visual disturbance).

Table 5: Symptoms of five different groups of breath-hold divers

Symptom	Taravana	Ama	Spanish	Australian	Competitions
Visual			X	X	X
Speech		X	X	X	X
Auditory			X		
Agitation			X		
Convulsion			X		
Memory loss			X		
Vertigo	X	X	X	X	
Headache			X	X	
Nausea/Vomit	X	X	X	X	
Paresthesia		X	X	X	
Paresis, paralysis	X	X	X		X
Incoordination			X	X	
Euphoria		X			
Poor concentration				X	
Disorientation				X	
Ataxia					X
Cardiac arrest			X		
Sphincter			X		
Fatigue			X	X	
Pain			X	X	
Lost consciousness	X	X	X		X

Common Factors

Factors causing neurological symptoms include dives in excess of 66 fsw (20 msw); with repetitive dives of three hours or more, a rapid rate of ascent and surface intervals of short duration. It has, however, been reported (20) that a BH diver performed repetitive dives for three-and-one-half hours to depths of only eight msw (26 fsw) and on surfacing developed severe headache, dizziness, blurred vision, vertigo, numbness and weakness of all four limbs and had to be rescued. No clinical evidence of pulmonary barotrauma was detected.

Mechanism

The etiological factors of DCS in BH diving have not been elucidated. Lanphier (21) looked at the surface/depth (S/D) time ratio of the BH dives and proposed that no limit of total time needs to be imposed if time at surface is at least equal to time at depth (S/D=1.0). However, if the S/D = 0.5, there is a risk of DCS in less than three hours of diving. This is supported by the Ama divers of Mishimi Island of Japan that their symptoms never appear on the first day of the diving week and that their symptoms only appear after at least three and a half to four hours of diving to depths of 66 fsw (20 msw) when the surface interval is less than the depth time, suggesting nitrogen accumulation could be a contributing factor.

Various mechanisms of DCS have all been postulated including venous bubbles bypassing the lung filter on repetitive diving; cardiac/intrapulmonary shunting; pulmonary barotraumas and bubble formation in the arterial circulation.

Treatment

Most BH divers do not appreciate that BH diving could cause DCS and consequently when they have symptoms they do not seek medical advice. Nonetheless, even without treatment, symptoms tend to subside and generally with no sequelae.

The Ama divers reported that their symptoms tend to disappear from 10 min to four weeks. The sensory symptoms took longer to recover. The Spanish divers' recovery time varied from 30 min to 72 h whilst the Australian divers reported a recovery time of 12 to 36 h.

No standard protocol of treatment has been agreed upon by the authorities. Divers have received surface oxygen and various treatment tables have been employed which included USN6, USN5, Cx12, Cx18, HBO 14.

Medications such as nifedipine, NSAID, heparin, steroid and diazepam have all been tried.

Conclusions

It would appear that DCS following breath-hold diving does exist as a clinical entity. Common factors in the development are deep dives in excess of 66 fsw (20 msw), conducted over a longer than three hour period with surface intervals shorter than breath-hold times. The symptoms reported are variable. Freedivers presenting with symptoms consistent with DCS should be offered hyperbaric oxygen therapy.

Acknowledgment

It is gratefully acknowledged that Dr Kiyotaka Kohshi introduced me to Mishima Island and to the Ama divers. Despite his predisposition to sea-sickness, he accompanied me to study the Ama divers at work.

References

1. Teruoka G. Die Ama und ihre Arbeit. *Arbeitphysiologie* 1931; 5: 239-251.
2. Schaeffer KE. The role of carbon dioxide in the physiology of human diving. In: *Underwater Physiology Symposium*. Publication No 377. Groff LG Ed. Washington, DC: National Academy of Sciences, National Research Council, 1955: 227-236.
3. Spencer MP, Okino H. Venous gas emboli following repeated breath-hold dives. *Fed Proc* 1972; 31: 355.
4. Nashimoto I. Intravenous bubbles following repeated breath-hold dives. *Jpn J Hyg* 1976; 31: 439.
5. Radermacher P, Falk KJ, Park YS, Ahn DW, Hong SK, Qvist J, Zapol WM. Nitrogen tensions in brachial vein blood in Korean Ama divers. *J Appl Physiol* 1992; 73: 2592-2595.
6. Boussuges A, Abdellaouil S, Gardette B, Sainty JM. Detection of circulating bubbles in breath-hold divers. *Proceedings of the 12th International Congress on Hyperbaric Medicine*. Flagstaff, Arizona: Best Publishing Company, 1998: 606-608.

7. Cross ER. Taravana: diving syndrome in the Tuamotu divers. In: Physiology of Breath-Hold Diving and the Ama of Japan. Publication 1341. Washington, DC: National Academy of Sciences, 1965: 207-219.
8. Paulev P. Decompression sickness following repeated breath-hold dives. *J Appl Physiol* 1965; 20(5): 1028-1031.
9. Bayne CG, Wurzbacher T. Can pulmonary barotrauma cause cerebral air embolism in a non-diver? *Chest* 1982; 81: 648-650.
10. Bruch FR. Pulmonary barotrauma. *Ann Emerg Med* 1986; 15: 1373-1375.
11. Fanton Y, Grandjean B, Sobrepre G. Accident de decompression en apnee. *PRESSE Med* 1994; 23: 1094.
12. Kohshi K, Kinoshita Y, Abe H, Okudera T. Multiple cerebral infarction in Japanese breath-hold divers: two case reports. *Mt Sinai J Med* 1998; 65 (4):280-283.
13. Kohshi K, Katoh T, Abe H, Okudera T. Neurological diving accidents in Japanese breath-hold divers: A preliminary report. *J Occup Health* 2001; 43: 56-60.
14. Kohshi K, Wong RM, Abe H, Katoh T, Okudera T, Mano Y. Neurological manifestations in Japanese Ama divers. *Undersea Hyperb Med* 2005; 32(1): 11-20.
15. Magno L, Lundgren CEG, Ferrigno M. Neurological problems after breath-hold diving. *Undersea Hyperb Med* 1999; 26 (suppl): 28-29.
16. Ferrigno M, Lundgren CEG. Human breath-hold diving. In: Lundgren CEG, Miller JN, eds. *The Lung at Depth*. New York: Marcel Dekker Inc., 1999: 573-574.
17. Desola J, Lundgren CEG, Batle JM, Lopez B, Alos R, Vilas F, Salinas A, Crespo A, Magno L, Ferrigno M. 30 Neurological accidents in Spanish breath-hold divers: Taravana revisited? *Undersea Hyperb Med* 2000; 27 (suppl): addition to session T.
[Note: This abstract was not included in the supplement. A sheet of paper was provided to attendees on the day of the meeting with the abstract and the statement "addition to session T for supplement 27."]
18. Batle JM. Decompression sickness caused by breath-hold diving hunting. 13th International Congress on Hyperbaric Medicine Program. Kobe, Japan, 1999: 87.
19. Wong RM Breath-hold diving can cause decompression illness. *SPUMS J* 2000; 30 (1): 2-6.
20. Williams D. Possible CAGE from breath-hold diving. *SPUMS J* 2000; 30(1): 17-18.
21. Lanphier EH. Application of decompression tables to repeated breath-hold dives. In: Physiology of breath-hold diving and the Ama of Japan. Publication 1341, National Academy of Sciences, National Research Council. Washington, DC. USA 1965: 227-236.

WORKSHOP DISCUSSION

DR. LUNDGREN: You mentioned the possibility of cumulative effects because the problems tend to occur towards the end of the dive day or after several days of diving. I think you said the cumulative effects of nitrogen. Would you mind being a little more specific? Do you include the possibility that it might be cumulative effects of subclinical trauma, perhaps? Because I suppose you would agree that the likelihood of nitrogen accumulation in the brain, to the extent that these are brain symptoms, which it looks like, is unlikely considering the cerebral circulation? But mini-traumas accumulating, would that be something you would consider?

DR. WONG: I would consider that, yes. What I said about the accumulation of nitrogen, is that we do not really know how long it takes for the body to eliminate nitrogen totally. Looking at nitrogen clearance of the U.S. Navy decompression table, it is considered to be 12 h following compressed air diving to be clear of nitrogen accumulation. My work with the pearl divers shows that even after two days in severe dives, bubbles are detected. I assume that in repetitive breath-hold divers they would have accumulation of nitrogen. And I do believe that after a day, you still have nitrogen on board. And certainly trauma, or brain injury, would be a problem.

MS. RIDGWAY: Just wondering with your study of the spearfishermen in Australia, you reported some confusion and disorientation and a few other common problems. Did you measure those or are they self-report?

DR. WONG: We did not have a neuropsychologist to do that.

MS. RIDGWAY: I like that you recommend that.

DR. WONG: We tried to get a neuropsychologist to come and work with us.

MS. RIDGWAY: Okay. I am here.

MR. KRACK: I was fortunate and unfortunate. Fortunate that we have experience to give to our students, unfortunate from what Dr. Potkin will show you later. But in 1999, I was utilizing scooters like the Spanish spearfishermen but not doing the amount of dives they were doing. I would do a warm-up to 40 m [131 ft], spend about two-and-one-half minutes total down and up, and in less than three minutes go to 60 m [197 ft] total down and up about two and a half minutes. And in less than three minutes do about an 80 m [262 ft] scooter dive. Approximately about seven minutes after surfacing, started to feel fatigued, impending doom, and then slowly I just kind of sunk away to unconsciousness.

It is interesting because at the time we were videotaping everything and friends of mine actually videoed the whole thing while I am unconscious for 18 min. So in three dives I was able to suffer a fairly severe type 2 neurological hit, which is what we assume it was. And because of this, we have also started to introduce a lot of oxygen decompression in free diving, even in relatively simple and shallow dives, simple and shallow being a relative term with Mandy and Martin. Fifty meters [164 ft] and deeper will sometimes utilize oxygen at about six meters [20 ft] for five to 10 min.

One of the things that we want to try to come up with is a list of common sense rules that free divers at all levels can utilize. After an hour of free diving that a 15 to 20 min break should be taken, should competitive free divers utilize oxygen decompression? I was wondering whether you get a sense for any rules of thumb that might be established.

DR. WONG: I do not think I can answer that question. I can tell you about the pearl divers, they are compressed air divers. They work in the farm and they dive to U.S. Navy tables. At the end of the day, even though there is no decompression required, they usually decompress for five to 10 min on oxygen at six meters [20 ft]. And they tell me – just word of mouth, no confirmation of any kind, no scientific study – that they do not feel so tired. They feel a lot happier. I really do not have any recommendation. Unfortunately, in the 1990s, the Submarine Escape Training Facility in Australia had a high incidence of DCS. I put forth a proposal to do a Doppler on the instructors and then I was going to recommend that at the last dive they go into a bell and breathe oxygen before they surface. But due to financial constraint, the Navy never funded this study.

MR. KRACK: I will ask this to everyone as well. Some of my symptoms were interesting that after I went unconscious they put me on oxygen, but my eyes were open. I was looking to the upper right. I was kind of clenched in the hands and doing this continuously with my feet. Then I started to get aggravated towards the end of that feeling, as I was kind of coming around, feeling like I was suffocated, tried to move the oxygen away, and I had about nine people pin me to the deck, which in my semiconscious state, agitated me even more. By 18 min I was around, coherent, and no other effects.

I went to the hospital in Cayman. They put me on oxygen and intravenous line, and said, it is not decompression sickness because you cannot get that free diving, and sent me on my way home without any treatment. What do those symptoms sound like? Is that a neurological decompression sickness?

DR. WONG: I would suggest that yes, they are.

MR. KRACK: Thank you.

DR. DOOLETTE: Thanks for the talk. That was great. Two points about your slide of plausible mechanisms. Except for pulmonary barotrauma, all of them relied on there being venous bubbles. I am not sure I would agree with that even though you found one paper that found venous bubbles. I find it easy to understand you could build up enough nitrogen in the brain during frequent repetitive diving to get bubble formation and almost all the symptoms you show are cerebral. So I would put that as a mechanism. And even the rapid resolution I could believe because I could imagine those bubbles would have a lot of carbon dioxide in them in breath-hold diving. So that would be the one I would put at the top of the list.

You described one paper that showed venous bubbles and they found it at 10 min and then not later. I have got almost all the bubble people in the seats here. Does anyone ever notice bubbles that peak in DCS or any dive at 10 min and then are gone? That seems really unusual to me and I wonder about that one particular odd finding.

DR. WONG: It was 10 s actually.

DR. DOOLETTE: Ten seconds and then no bubbles at any later time. I have never read that paper, and I do not know how good it is, but I would be reluctant to believe anything that involves vascular bubbles. I do not think you get enough nitrogen buildup in the body.

DR. WONG: Thank you. I really cannot answer your question. And also Dr. Kohshi is going to talk about mechanism and you can ask him then after you have heard his talk.

DR. DOOLETTE: It was not a question, just a comment, then a question of these people.

DR. RAMASWAMI: You mentioned there were several cases from the submarine escape training tank. In the United Kingdom submarine escape training tank it is the habit of the instructors to breathe from air filled blisters on the side of the tank which are at depth. Do they do that in Australia as well?

DR. WONG: Yes. Some of the instructors were trained in the United Kingdom as well.

DR. RAMASWAMI: So it is not really a pure free diving experience?

DR. WONG: No. I mentioned that they breathe from the bell as well as there are blisters on the side and they freedive.

MR. HUGGINS: In response to Dr. Doolette's question, I know I have heard of at least one set of bubbles from a series of free dives. The rest are sort of questionable and still in review, but I have got a slide that I can show later that shows the dive series and it was about 15 min post dive that we had a grade one bubble.

DR. WONG: Thank you.

DR. LEHNER: You mentioned Ed Lanphier. He was my senior colleague at the University of Wisconsin at Madison. One of the interesting aspect of the research we have done with the UW sheep model is the fact that the first series of dives we did with the UW sheep we did them for a 24-hour duration and four-hour duration, and virtually saw nothing from the standpoint of clinical signs that would indicate CNS involvement.

When we went to the half-hour dives, however, there were a profoundly important number of CNS involvement cases where we found spinal cord decompression sickness in the animals with paralysis that we would never seen before. This is something that was noted in one of our reports in the past. I think it is important in terms of loading and unloading of gases so that one sees a disproportionate number of limb bends and with limb bends, also osteonecrosis versus what one sees in short deep dives, short deep divers, showing a high frequency and proportion of central nervous system clinical signs.

That is how I began my own career with Ed Lanphier looking at animals and seeing their response to hyperbaric exposures of different durations being associated with different, clearly different clinical manifestations.

DR. YOUNGBLOOD: For the sake of complete chronology, I think I remember another paper that you may not have mentioned, and it is a friend of mine Charlie Aquadro who was a Navy diving medical officer and sustained what was believed at that time to be one of the early cases reported in, I think, the Southern Medical Journal. He was diving with underwater swimmers school in Key West, repeated breath-hold dives during the day and got signs and symptoms of decompression sickness.

DR. BENNETT: I think we must not get too confused with the broader aspects of decompression sickness. We have got something very different here. The signs and symptoms clearly to me certainly look like brain and nothing much else. Recreational scuba divers today are predominantly spinal cord. You do not see a lot of pain, only perhaps with Navy diving following different profiles.

So I think you have something very different. I really would like someone to talk about free bubble forming in the brain tissue. It is not in the blood. But to get in the tissue, have spontaneous bubbles and they resolve as the blood takes that gas away very quickly. You might want to put a Doppler on

the carotid to see if you hear any bubbles going by and then you get some kind of scan on the brain and see what is happening in terms of that. You may be able to answer the problem.

But I think that is the likely mechanism. We should not confuse them. They are different aspects together of what we might call decompression sickness. And they are three different situations with different kinds of diving.

DR. FEINER: Arterial blood itself is a very, very fast tissue. It is so fast it is simply assumed to be like inspired gas. Is there something fundamentally different about this whole natural experiment in that you are using vastly higher inspired partial pressures of nitrogen over very, very short periods of time? It is very, very different. And arterial blood is fast enough that it is going to equilibrate with those levels of partial pressure quite quickly, whereas the tissues themselves will not equilibrate over that short period of time. So it is certainly possible that those bubbles are forming in arterial blood itself and, therefore, would not be seen in venous blood which would have lower partial pressures.

MANIFESTATION OF DECOMPRESSION ILLNESS IN JAPANESE AMA DIVERS

Kiyotaka Kohshi, MD¹
Yoshihiro Mano, MD, PhD²
Robert M. Wong, MB, FANZCA³

¹ Division of Hyperbaric Medicine & Department of Neurosurgery, University Hospital of Occupational and Environmental Health, Kitakyushu, Japan

² Department of Health Education, Division of Comprehensive Health Nursing Sciences, Graduate School of Allied Health Sciences, Tokyo Medical and Dental University, Tokyo, Japan

³ Department of Diving and Hyperbaric Medicine, Fremantle Hospital and Health Service, Fremantle, Australia

Introduction

Decompression illness (DCI) is mainly induced by compressed air diving. However, we have experienced a small number of cases of professional breath-hold divers (Ama) being afflicted (1-3). Although a few reports about diving accidents in breath-hold divers have been published from some areas (4-6), there are questions about this condition. The experience of Japanese Ama divers is not well documented. Although 'Taravana' diving syndrome is well known, this is an equivocal condition. What are the characteristics of diving accidents in breath-hold divers? In addition, what are the mechanisms of diving accidents? We present the clinical manifestations of diving accidents in Japanese Ama divers.

Interview Survey

Previously, we experienced two Ama divers with a history of diving accidents, so we went to their island situated in the Japan Sea to investigate their diving patterns and diving accidents. About 100 Ama divers are working on their island, and 30 or 40 divers are partially assisted Ama divers (called *Funado* in Japanese). All partially assisted Ama divers are male, and their diving depth is deep. We performed a direct interview survey at a village on this island in 1998 (3). Our survey considered diving pattern, diving accidents, symptoms and any development for each Ama diver.

The mean subject age was 45.7 ± 6.9 years old (range, 39-63). All Ama divers started their profession at the age of 15-16 years and had continued working for more than 20 years. They wore wetsuit, fins and weight belt. Weight belts were about 8 kg (18 lbs). Diving bar weight was 18 kg (40 lbs), standard on this island. Ama divers descend passively with a bar weight to the bottom, and then swim to the surface without assistance. Diving depths are 10-30 msw (33-98 fsw), 20 to 30 times per hour. Recently, diving depth is measured with fish finders. In general, Ama divers' working time is about five hours in the sea. Diving time is separated, two shifts in a day. The time of the morning shift is three to four hours. And the afternoon shift is one or two hours. They take a 30 min lunch break between the shifts.

We interviewed 16 Ama divers; nine had a history of diving accidents. Diving accidents happened during or after more than three hours of deep and repeated dives. All the symptoms were neurological

disorders, such as motor paresis, sensory numbness, unconsciousness, and convulsive seizure. Motor weakness was the most common symptom (7 cases); the second was sensory numbness (4 cases). In addition, 13 divers occasionally felt dizziness, nausea and/or euphoria after long-time diving. We present the case reports of two Ama divers.

Case Presentation

A 44-year-old Ama diver admitted with stroke at a local hospital (1). He said the condition developed while diving. He started to dive at around 0930 and continued until 1300 for lunch. His diving depth was 15-25 msw (49-82 fsw). After repeated dives, on the boat, he noticed nausea and double vision. Ten minutes later he was unable to speak, had motor weakness and sensory numbness in his right side. Two weeks after the accident, brain magnetic resonance imaging (MRI) showed two small infarctions. His neurological disorders disappeared in a few weeks.

A 43-year-old Ama diver said he had a history of diving accident nine years before (1). After deep and repeated breath-hold diving, he noticed hemiparesis and sensory numbness in his left side. This case was more serious. He lost consciousness three hours later after the onset of motor weakness. After improving of the hemiparesis and recovery of consciousness, he had a convulsive seizure. When evaluated nine years after the accident, he has no neurological deficits, but his brain MRI showed multiple infarctions.

Two other Ama divers had acute diving accidents and we followed their neurological and MRI findings (2). One of them was a 33-year-old male. He lived in another village, but his diving pattern is similar to other Ama divers. He began to dive at 0920 and continued diving to more than 20 msw (66 fsw) until noon. After a 20 min lunch break, he started to work again. He noticed dizziness and blurred vision at around 1400. He consulted to a doctor on fourth day, and his MRI shows two brain lesions. The infarction size regressed for several days. Five years later he complained of a partial visual deficit, and his MRI showed an old infarction in the left temporo-occipital lobe.

A 39-year-old Ama diver lived on another island. His diving patterns were similar. He had a history of three diving accidents. The first happened at 17 years of age, and he suffered similar symptoms during repeated events at ages 25 and 27 years. The first three diving accidents evoked left motor weakness, but the final accident included right motor weakness and sensory numbness. His brain MRI on third day showed multiple infarctions, acute and old stages.

Development Mechanisms

Mechanisms for DCI in breath-hold divers have been described (Figure 1) (7). After deep, repeated dives, bubbles are formed in venous side and travel through the heart to the lungs. Microbubbles can pass through the pulmonary capillaries, but in general these microbubbles are harmless to tissues. An experimental study showed that microbubbles transiently impair the blood brain barrier (8). At first, we thought the major mechanism of DCI in breath-hold divers was such microbubbles (7). But from the MRI findings of Ama divers with DCI, we do not now think microbubbles are the major mechanism of DCI. Since Ama divers have large cerebral infarcts in arterial branches, we should consider other factors as major mechanisms of DCI. Large or small bubbles are normally retained or trapped at small pulmonary arteries or pulmonary capillaries. When Ama divers reach to the bottom, we think that bubbles 'trapped' at the lung are compressed and easily pass through pulmonary capillaries. Such bubbles passing through the lung enlarge at the surface and the bubbles induce cerebral arterial gas embolism. In addition, there is a possibility microbubbles are related to trapped bubbles. Trapped bubbles and microbubbles are mixed, and these bubbles probably induce cerebral

infarcts. Other mechanisms, such as cardiac shunt or de novo bubbles should be considered, but we do not think these are major factors of DCI caused by commercial breath-hold diving.

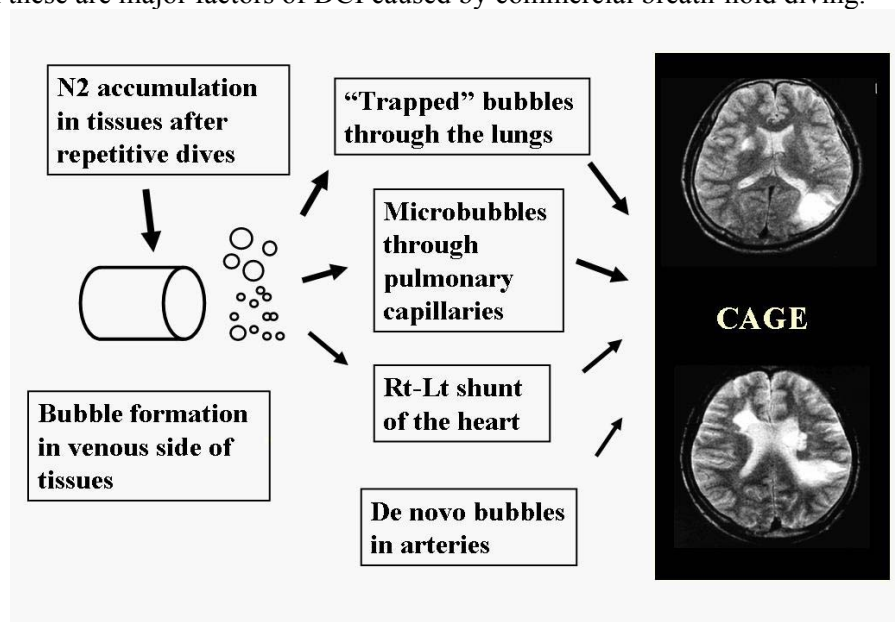

Figure 1: Mechanisms of decompression illness in repeated breath-hold dives (modified from 2)

Our questions for future studies of DCI in breath-hold diving are as follows: 1) why does breath-hold diving cause only brain injury, especially cerebral stroke, and 2) why are DCI symptoms different between breath-hold divers and compressed air divers.

References

1. Kohshi K, Kinoshita Y, Abe H, Okudera T. Multiple cerebral infarction in Japanese breath-hold divers: two case reports. *Mt Sinai J Med* 1998; 65:280-283.
2. Kohshi K, Katoh T, Abe H, Okudera T. Neurological accidents caused by repetitive breath-hold dives: two case reports. *J Neurol Sci* 2000; 178:66-69.
3. Kohshi K, Katoh T, Abe H, Okudera T. Neurological diving accidents in Japanese breath-hold divers: a preliminary report. *J Occup Health* 2001; 43:56-60.
4. Batle JM. Decompression sickness and breath-hold diving hunting: a study of about 30 cases. *Proceedings of the 13th International Congress on Hyperbaric Medicine*. Best Publishing Company, AZ, 2004:139-146.
5. Magno L, Lundgren CEG, Ferrigno M. Neurological problems after breath-hold dives. *Undersea Hyperb Med* 1999; 26(suppl):28-29.
6. Wong R. Taravana revisited decompression illness after breath-hold diving. *SPUMS J* 1999; 29:126-131.

7. Kohshi K, Wong RM, Abe H, Katoh T, Okudera T, Mano Y. Neurological manifestations in Japanese Ama divers. *Undersea Hyperb Med* 2005; 32:11-20.
8. Hills BA, James PB. Microbubble damage to the blood-brain barrier: relevance to decompression sickness. *Undersea Biomed Res* 1991; 18:111-116.

WORKSHOP DISCUSSION

DR. RISBERG: I do not understand how you can know that these infarctions were due to decompression illness. They could be coincidental vascular events. I understand that they occurred during diving, but why could not there be other mechanisms?

DR. KOHSHI: Bubbles are made in venous site and cause cerebral infarction, I suppose. The brain is a sensitive organ. Such bubbles gather in the lung, and they are compressed at the bottom and they expand at the surface. These enlarged bubbles induce cerebral infarction. In general, the rate of stroke in young men is very low.

DR. BENNETT: I think this is a good example for us that we are dealing with something very different. This is a CNS decompression sickness situation, which is not ordinarily seen very often in most of the decompression diving, so it is something new. It needs to be looked at that way and researched that way. And I think you are still talking about bubbles is the most likely situation because in recreational divers, the spinal cord gets affected. And I think we are talking about bubbles in the spinal cord that are causing the problem.

Another factor you mentioned nitrogen narcosis again. I have got to get this out of the way. Let us look at a simple situation where 80% of one atmosphere with 80 units of nitrogen. That is all you have got in your body. Nitrogen narcosis comes on at 100 foot of compressed air, when you have four times that. Four-eighths is 32 units. You need 32 units of molecules to go into the membranes, swell the membranes and cause narcosis. You cannot have nitrogen narcosis. Euphoria, yes, but from another cause.

DR. LUNDGREN: I disagree, Dr. Bennett. There is quite some difference between distributing the nitrogen throughout your whole body during ordinary diving and distributing what is essentially some 7, 8 liters of nitrogen compressed to, say, 17 atmospheres in the lung, and distributing it to what is, for all practical purposes, only the brain because of the circulatory changes due to the diving response.

To return to Dr. Kohshi's interesting presentation, I suppose there is a parallel between what you have observed in terms of symptomatology and histology, et cetera. With that, and what has been described from deep breath-hold divers, primarily in the European scene, namely a few cases where the divers have been brought very quickly to recompression treatment with complete, very rapid resolution, so that certainly supports your interpretation of the etiology of this phenomenon. Thank you.

DR. KOHSHI: I think impairment would depend on the location of the cerebral infarction.

DR. SMITH: I am agreeing with what Dr. Kohshi just said on some level. What is so different about tank diving and breath-hold diving is the lungs. The fact that the lungs are compressed and on re-expansion, that is where the nitrogen could go through an atrioventricular shunt like your brain. Since it is not seeming to go anywhere else, it really, I think, implicates it. I think it is certainly an area for

further research to see if it is not strictly this lung to brain connection, which seems to be unique for breath-hold diving.

DR. BENNETT: I do not believe that either, but a simple study can prove it. If you want to make some breath-hold dives with helium, you will find out you have no narcosis, if it is nitrogen narcosis, which it is not.

DR. MACRIS: I would like to answer Dr. Risberg's question. I was in Japan and saw Dr. Motto's presentation. I think when they looked at the Ama divers, they took great pains to rule out other risk factors such as smoking, hypertension, diabetes. I think that they looked at those factors and illuminated them in those cases in the original presentation when they had the hyperbaric conference two years ago.

BRAIN FUNCTION IMAGING IN ASYMPTOMATIC ELITE BREATH-HOLD DIVERS

*Ralph T. Potkin, MD¹
J. Michael Uszler, MD²*

¹ Beverly Hills Center for Hyperbaric Medicine, Los Angeles, California

² Santa Monica Imaging and Treatment Center, Santa Monica, California

Introduction

Breath-hold divers have been known to have adaptive mechanisms that allow prolongation of apnea beyond the limits of non-diving subjects. Central nervous system abnormalities are well described in scuba and breath-hold divers suffering from symptomatic decompression illness and barotrauma. Brain magnetic resonance imaging (MRI) abnormalities such as multiple T2-weighted hyperintensities have been reported in professional breath-hold divers who had clinically apparent neurologic symptoms and neurologic findings after repetitive dives (1). The central nervous system effects of repetitive breath-hold dives in asymptomatic divers are unknown.

Methods

Five breath-hold divers were studied. All divers had a dive history of over 1000 dives to depths of at least 30 m (98 ft) over a period of at least five years. No subject had any neurologic complaints. Physical examinations were conducted on the divers followed by brain imaging which included MRI and brain single photon emission computed tomographic (SPECT) scans. Each subject was in a resting state in a semi-darkened room for approximately 10 min when given an intravenous injection of Tc-99m Ceretec (30mCi) via a previously placed venous catheter. At least 45 min later SPECT imaging of the brain and entire head was performed with the subjects resting quietly in the supine position. The imaging device was a Philips triple-head IRIX emission tomographic scanner using high resolution collimation in 128x128x16 deep matrices. Following image reconstruction and attenuation correction, matrices were subjected to oblique reorientation for standard three orthogonal image positioning in transverse, coronal and sagittal axes and 3-D display. The three axis views were displayed in gray scale format using 15% background thresholding. The 3-D cerebral cortical uptake images were displayed using the manufacturer's proprietary color scale, thresholded at 60% of maximum brain uptake. Comparison with a similar age reference population data base was also performed.

Results

Neurologic exams and brain MRIs were normal in all subjects. However, brain SPECT imaging was abnormal in all five subjects, demonstrating both large focal and/or diffuse areas of hypoperfusion and hyperperfusion in the frontal and temporal lobes and cerebellar hemispheres.

Two subjects had activation studies as well as resting studies. One demonstrated normal brain activation and the other showed persisting perfusion abnormalities.

Conclusions

The long term consequences of repetitive breath-hold diving on the central nervous system are unknown. Other investigators have noted brain imaging abnormalities in symptomatic breath hold divers with abnormalities on neurologic exam. We performed brain imaging on five asymptomatic breath-hold divers with multiple breath-hold dives to depths exceeding 30 m [98 ft] over a period of over five years. At the time of brain imaging, neurologic symptoms, physical examinations and brain MRIs were normal. However, brain SPECT scans were abnormal in all five divers. Repetitive breath-hold diving may be associated with asymptomatic brain function abnormalities. Following a larger cohort of patients over an extended period of time and/or including neuropsychological evaluations may be of value to determine the clinical significance of the imaging abnormalities observed.

Reference

1. Kohshi K. Neurological accidents caused by repetitive breath-hold dives: two case reports. J Neurol Sci 2000; 178(1):66-69.

WORKSHOP DISCUSSION

DR. WONG: Can you suggest why the frontal and temporal lobes and cerebellum hemispheres selected for the high resolution?

DR. POTKIN: I am not a scanning physician myself, I am a pulmonologist. But the frontal and temporal lobes are real sensitive to hypoxia. So I think those areas might be more susceptible.

DR. FREIBERGER: Do you have a control series of SPECT scans that we can compare these with? Because I am not really familiar with SPECT scans and I am not sure if the utility of them. How often do you see these type of abnormalities in people who do not dive?

DR. POTKIN: The scans I showed on the left of each panel were normal control studies. Each abnormal study was compared to a matched control population study.

DR. FREIBERGER: So these abnormalities are seen only in divers?

DR. POTKIN. No. As I showed you on the previously slide, this is differential diagnosis of abnormal SPECT scans.

MS. RIDGWAY: Did you screen these five people for these problems and did they admit to how many previous what I call negative neurological events, any of the previous concussions, how many blackouts did they have? How many sambas did they have over their diving career?

DR. POTKIN: That is a good question. Unfortunately, they were not screened. This is a pilot study. We needed to start someplace. Some of them had remote automobile accidents, 30 years or so earlier. One of them we know had a definite decompression hit. So they are not a totally normal population, besides the fact that they are breath-hold divers so they cannot be normal anyway.

MS. RIDGWAY: It would be interesting to look at that. I think without that data it is not really conclusive as to why they are showing those SPECT changes. Would it be possible retrospectively to get some interview about these other co-morbid possibilities?

DR. POTKIN: Number one, I think it would be very important. Two, I think it needs to be studied in a more organized and controlled fashion. Number three, I think it would be critical for us to get neuropsychiatric evaluations of these five patients to see if there is any clinical correlation especially with the data that you presented earlier in this meeting. So are you offering to do these?

MS. RIDGWAY: All the time. And I do have some tasks that are nonverbal that we could use. And the ones I used in the major dive study, are ones that I can use cross-culturally. And you do not need to speak English. That might be quite useful to Dr. Wong's study as well. That would be great.

DR. POTKIN: Thank you very much. I appreciate it.

DR. KOHSHI: Do you plan to study using a PET study?

DR. POTKIN: No.

DR. KOHSHI: Do SPECT scan and PET scan detect cerebral function?

DR. POTKIN: I think PET and SPECT scans both look at function. Although, PET is a little more quantitative and thought to be a little better test. But nonetheless, having SPECT scans on these patients with the abnormalities noted does not negate the fact that we did not do PET scanning.

DR. LINDHOLM: I find this study very interesting. You told me about this earlier. And I just have one question. I know you are a pulmonologist, but you have your colleague back home. What happens if you give a person, benzodiazepines or something and run them in the SPECT. Taking a couple Valium is something that could be done in human subjects fairly okay, I would say. You can get an institutional review board for that. Because this represents some kind of hypometabolism. Maybe it could be interesting to see if there are some drugs or some other effects that cause hypometabolism in the brain. Apparently, you have not seen any deficits in their performance in terms of cognitive performance so far, whether they have hypometabolism in areas of the brain that they do not use. We do not know. But it could be an interesting – you could do maybe some pharmacology to complement the study.

DR. POTKIN: I think that would be a good idea. But I think the key to it would be getting the neuropsychiatric testing because that really tells you if this is clinically significant and it really is a very sensitive instrument for looking at executive dysfunction, brain dysfunction.

DR. YOUNGBLOOD: I wondered, have you offered them any therapy, such as hyperbaric oxygen with a follow-up SPECT scan?

DR. POTKIN: I have not. Is that a DAN-covered diagnosis yet?

DR. YOUNGBLOOD: I do not think it is UHMS approved yet, but maybe you could help.

USE OF ELECTRONIC DATA LOGGERS WITH BREATH-HOLD DIVING

Karl E. Huggins, MS¹
Martin Stepanek²

¹ USC Catalina Hyperbaric Chamber, Avalon, CA, USA

² Performance Freediving, Fort Lauderdale, FL, USA

DR. POLLOCK: Throughout the workshop there have been references to dive computers for monitoring breath-hold dives. Karl Huggins and Martin Stepanek kindly offered to share some insights.

MR. HUGGINS: One of the things that we can do with the technology available today is to get good recordings of the profiles freedivers are performing. Instead of looking at maximum depth and surface to surface time, or even dive computers with 15-30 s sample rates, you can record profile with 1-5 s resolution. The device we used while working with Performance Freediving team was the ReefNet Sensus Pro unit (Figure 1). Their newest model, the Sensus Pro Ultra, can be set up to record the divers' depth every second and can store 150 h of dive time at that resolution. There are other devices available, for example, some Citizen and Suunto watches are able to record high resolution (1-5 s) profile data and, unlike most dive computers, are small and unobtrusive.



Figure 1: Sensus Pro dive profile recorder

I want to share some profiles we recorded in Cayman this year. The first profile represents a series of dives done with scooters while doing a film shoot (Figure 2). The recording shows 20 fsw (6 msw) oxygen breathing dives between the first and second deep dives and the second and third deep dives.

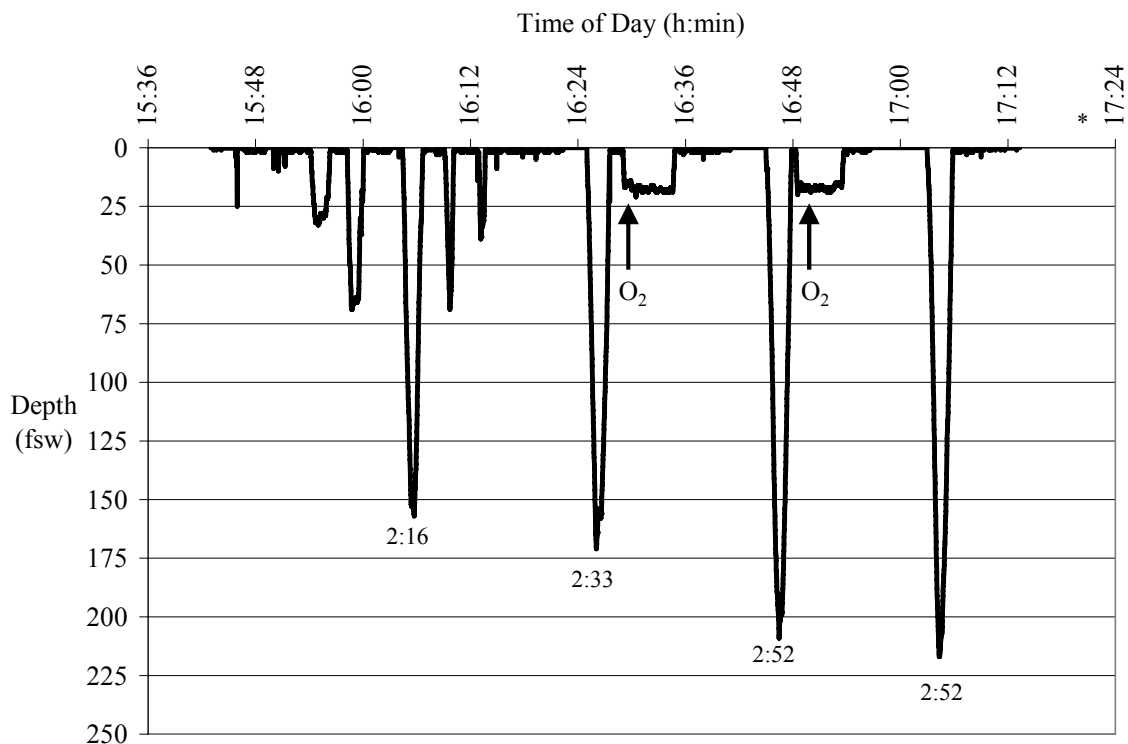

Figure 2: Dive profiles resulting in right subclavian Grade I Doppler scores identified during both rest and movement. Times shown at the bottom of individual dives are surface-to-surface times (min:s). 'O₂' indicates dives during which oxygen was breathed to clear inert gas. * = time of Doppler reading.

The interesting observation from this profile is that about 15 min after surfacing from the final dive the subject had definite Grade I Doppler scores at rest and during movement in his right subclavian. When asked if he was doing anything different with his right arm he reported that during his time at 20 fsw (6 msw) breathing oxygen, he was slightly positively buoyant and had to hold on to a line to stay down. He stated that he held on to the line with his right hand and that his right arm was bent over his shoulder behind his back. This is the only thing I can think of that might have contributed to the fact that even with oxygen breathing, we were subsequently able to identify bubbles in him.

The second plot shows profiles from four days of diving (Figure 3). It is the same individual doing the same workout dives each day. Of interest here is just how close these dive profiles are to each other day to day. Since these profiles are from Martin Stepanek, he can explain his goals so we can get insight into how he and others work up their dives.

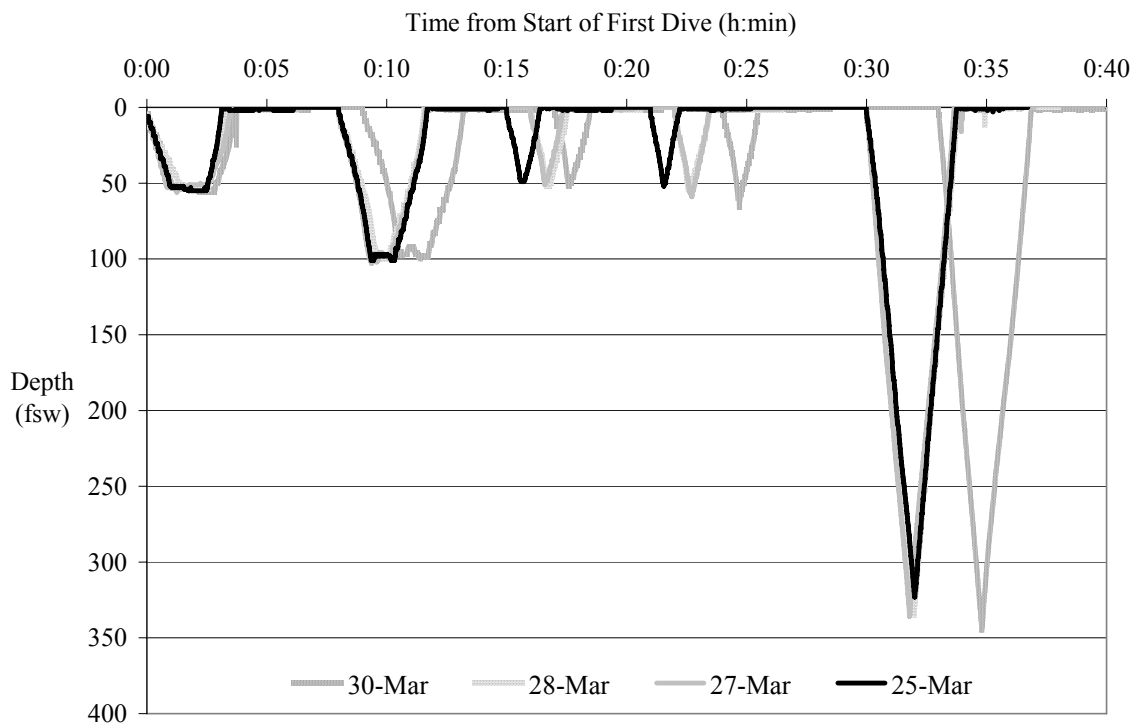

Figure 3: Four days of workup dives

MR. STEPANEK: The different line characters indicate different training sessions. You can clearly see the different depths to which I dived. The deep dives were what we call target dives. That is the main training dive.

The workup dives show a slow progression as we try to get deeper the closer we get to the main event.

The interesting thing you can see is the consistency of these dives. It is been presented here earlier, that the benefits we get from diving response and diving reflex in response to our dives are strongest on the third dive. It increases the level of hematocrit and the bradycardia that we experience. So, most divers will do a short series of warm-up dives, typically three or four, to prepare for the best performance.

You can see the first dive is to 50 ft (15 m), holding for approximately two minutes on the bottom. The five minute surface interval allows for good recovery. The next dive is to 100 ft (30 m) and again includes about two minutes on the bottom.

The next group of shallower dives with no hold on the bottom are actually exhalation, or empty lung, dives. Because, again as was presented today, the strength of the diving response and diving reflex depends on the compression of your chest and lungs. We use exhalation dives to amplify the effect of pressure on our lungs.

The next surface block represents a couple of minutes of breathe-up preceding the final dive. You can see that the swimming speed for both descent and ascent on the final dive is approximately $1.0 \text{ m}\cdot\text{s}^{-1}$ ($3 \text{ ft}\cdot\text{s}^{-1}$), which is an efficient speed for the gear we use.

WORKSHOP DISCUSSION

MR. KRACK: Something else to notice is the precision accuracy of the timing of Martin's dives. The consistency of both dives and surface intervals is marked. The ritual of the pattern of dives and the timing of dives is very important.

DR. ANDERSSON: I was wondering about the term exhalation dives, what you actually mean by that? It could be anything from starting slightly below your total lung capacity to starting at FRC [functional residual capacity] or residual volume. I have heard different explanations from different divers.

MR. STEPANEK: The procedure does vary. Each diver has a different way of doing it. Those who prefer to do FRC dives, which has you starting with more air in your lungs, tend to dive a bit deeper. I started the dives you saw plotted here essentially at my RV [residual volume]. If I do an FRC dive, I would have to go deeper to get the same effect with my chest flexibility. I do not want to do that before a target dive.

PANEL DISCUSSION

Editor's Note: The following text was excerpted from a transcript of the meeting provided by a court reporter. Editorial changes were made to correct grammar and remove extraneous comments. Every effort was made throughout to retain the spirit and intent of the original discussion.

DR. LINDHOLM: Now we are going to have a panel discussion. Tanya Streeter is not here with us today. She did not tell you, but she had to go to the Caribbean for a photo shoot with dolphins for Discovery Channel. She was not thinking that we would be very sorry for her.

DR. VANN: I want to put out a speculation for discussion. And this concerns mechanisms for if such things as Taravana and these Ama strokes that we have seen are really decompression sickness, which, of course, nobody believes.

But there was a study done back in the 1970s, I believe, by Brian Smith at Oxford. In which he, with an Ama model, he showed that with very short surface intervals between dives bubbles could be redistributed, bubbles that were trapped in the lung from a previous dive could be redistributed into the arterial circulation. He was investigating what was known as the arterial paradox.

This might give us a mechanism for what obviously appears to be a phenomenon that is very different from what most divers that we know of with decompression sickness. And one could continue the speculation by imagining that initially bubbles that formed on ascent from multiple breath-hold dives could be very small and possibly so small that they would not be detectable by Doppler, in which I understand the threshold is somewhere between 30 and 50 microns.

We certainly know that bubbles, very small bubbles, will pass right through the pulmonary capillaries. And we did some injections in ourselves, some small, four micron bubbles, to see if we could see them. And they went right through and appeared in the left side of the heart with no problem at all.

So if the threshold for passage through the pulmonary capillaries is on the order of 21 microns, you cannot see these bubbles, perhaps with multiple dives some of them are getting through. And then you can imagine with the up and down, particularly for great depths, these bubbles go on to expand, if they get into the cerebral circulation, and they certainly could go through, and as we have seen from many studies, denude the endothelial linings of the brain and perhaps lead to some of these strange findings.

DR. LUNDGREN: It is entirely to be expected that bubbles of the size that you mentioned go through to the left heart. This relates to the technique that is employed when you use bubble preparations as ultrasound contrast media. So that makes perfect sense. If they then get stuck in the lung and subsequently, after shrinking, as you suggest, travel up to the brain, that sounds like a very reasonable point.

DR. BRUBAKK: I have to comment on that. You do not actually need any bubbles to come through at all. We have done studies and looked at endothelial function on the arterial side in divers where we could not detect any bubbles at all. And we found that there is a reduction in function on the endothelium on the arterial side. The problem in the mechanism is that the bubbles were, even very small bubbles, undetectable would change the properties of the endothelial wall of the venous side,

could use some activated endothelial cells that could easily go through, and they are very small so they could easily go through.

It is quite possible that what we are seeing here is some type of chronic inflammatory process that can explain why we get these strange things because they are very strange. And it must be a little different from the normal decompression problems. And probably an explanation could be that there is actually very little bubbles at all that goes into the arterial side and make these symptoms. And that there are very low – the reason for that is there is no growth of any bubbles that might go through because there is very little supersaturation.

So it is an interesting observation. It looks clearly it is something that has to do with decompression, as you are only getting when you are doing multiple dives. The interesting is why the symptoms disappear so quickly.

DR. LUNDGREN: Except that that does not quite jive with the idea that it is chronic phenomenon, right.

DR. BRUBAKK: Well, the inflammatory processes are very dynamic. Could easily be an inflammatory process could easily have a time constant of 24 h. It is no problem at all.

DR. LUNDGREN: Excuse me, but we hear that these symptoms sometimes resolve in minutes, not hours.

DR. STOLP: I want to reiterate a comment that was brought up yesterday. It has to do with terminology and that last question at the end of the last presentation reminds me of that.

We have to be very careful to define what it is we are talking about. Hyperventilation keeps coming up. Hyperventilation is alveolar ventilation resulting in a PCO_2 less than 38 or 40 mm Hg. That is different than cleansing breaths. It may or may not be hyperventilation. It is very important to define that.

Similarly, performance dysfunction that you may see at depth might be nitrogen narcosis, might be HPNS [high pressure nervous syndrome]. It is probably a combination of all of those, metabolic factors, carbon dioxide toxicity, hypoxia. I would not call it nitrogen narcosis until we know. And we have come up with another terminology to find out. Because once you put a tag on something, it is going to stick for a long time. It might make all the future research hard to define and clarify.

DR. LINDHOLM: One of the discussions when we started to plan this symposium was that we were not going to have to agree on anything, basically, because we knew that two days would not be enough if we would have to agree on terminology or recommendations. But it is a very important thing. For example, shallow water blackout is a confused term as far as I am concerned. So it is a very good suggestion, and I think we can all think of these issues.

MR. LANG: I am wondering if the panel could disagree on freediving in between scuba dives?

MR. KRACK: Yes, definitely. We recommend that your days of freediving or scuba diving be separate, and that you do not partake in freediving activities between scuba dives. We sometimes get, well, if I could, what could I do, what would be the lesser of the evils? And, obviously, freediving first and then scuba diving would be the preferred way of hurting yourself as opposed to the other way around, but we recommend keeping them separate day by day.

DR. MACRIS: Again, I want to comment on some of the very good points that have come out. I think it is wonderful Dr. Butler mentioned setting a limit on our, I guess we want to say, diving. But for those who are not – for breath-hold diving. But for those who are not researchers but are clinicians, what does the body feel now about whatever this syndrome is when we have a person who typically we would say has no decompression obligation, who surfaces and we have ruled out the other causes, whether they be smoker, diabetes, surfaces with a new neurological deficit. Are we going to treat these people – that is persisting – are we going to put them in a chamber now if it is only breath-hold diving? What is the recommendation if even a not-agreed-upon recommendation?

DR. LUNDGREN: You can always go by the old golden rule that has always applied in this general context, when in doubt, recompress.

DR. LINDHOLM: I think it would be wise to try to treat. We were discussing it here. Why not, if they improve with pressure. We think that this has something to do with nitrogen, whether it is a new version of the decompression sickness or it is another way of symptoms that we have not sort of worked out yet. But why not try to treat.

There might be legal aspects of this issue. There was a UHMS workshop in Sydney two years ago where in-water recompression or not recompressing some minor symptoms was discussed. And they had invited a lawyer who concluded that you have to treat as long as there are any recommendations that say that, to reduce the risk of legal action. That was the way I understood him.

Why would you not treat someone with neurological symptoms?

DR. MACRIS: I would have no problem treating somebody because after seeing the presentations in Tokyo and anecdotally as a Navy diving medical officer and a civilian over the years, I have had divers come up who have done deep dives and have come up with neurological symptoms. We previously let them resolve over time, because we never believed that you can get DCI that way. Now we are describing a new phenomenon. And now I feel, what I am getting is that in Europe there are some references made to the Europeans treating these people and having resolution. I do not know if it was expanded upon, but I think now I would treat. I think most of us would, and we would not be criticized for it.

DR. BUTLER: I think that is a great question based on the presentations that we have had here the last two days. I would like to turn it around. Is there anybody here who would like to take the con position for if you have a diver who comes up from a deep breath-hold dive and he has got confusion that persists, is there anybody here who does not think it would be a good idea to recompress that diver?

UNIDENTIFIED SPEAKER: I would just point out that Dr. Zhang's work says that there is a therapeutic window for the neuroprotective role of hyperbaric oxygen, and that you can significantly exacerbate post-hypoxic ischemic insults with a single treatment outside of six hours. And so just like thrombolytic therapy, there seems to be a therapeutic window for this potential neuroprotective role of hyperbaric oxygen. I would never pretend to speak for Dr. Zhang; he will be here on Friday talking about this. But his papers in 2005 show that there is a dosing and timing issue here, and that you sort of need to be aware of that if you are thinking about a single-time use of hyperbaric oxygen for a persisting hypoxic symptom.

DR. BENNETT: One note of caution. I would be a bit leery until we know more about using a table six and pumping more nitrogen out there. I think I must be happy with an oxygen treatment table and

see where you go because we have those available. And we do not know quite what we are doing here, and to put more nitrogen might make it worse.

DR. SMERZ: To answer Dr. Butler's question from my perspective I think we have to be cognizant before we race off and just do what we have in the past, put people in the chamber until we find something else. I think technology has driven medical practice in such a way that we have to consider other possibilities which might be just as important. For example, merely because somebody is in the water and comes up with a hemiparesis does not mean that they have automatically had a diving-related event. It is possible that they have had a thromboembolic stroke. If so, TPA [tissue plasminogen activator] is required quickly so I think we are constrained to make that diagnosis a little sooner than we did before. My comment, be careful about immediately putting somebody in the chamber without considering all the other medical possibilities to make that differential diagnosis beforehand.

DR. RISBERG: Thank you for a very useful seminar. I really learned a lot. When I return back to Norway though, these kind of discussions are okay, what will happen when you do apnea diving, what will happen to the human body. The problem arises if you try to provide medical support to groups doing apnea diving. In that moment, at least in Norway, there will be colleagues and groups saying, you are not supposed to do that. This is not acceptable. This is on the edge of doing good medical work. Is this something you find in the U.S. and in other countries as well, that is, giving medical support to apnea divers trying to extend the boundaries and trying to reach new personal records or even professional records?

DR. LINDHOLM: I will answer that. I have come across this sentiment among some Swedish doctors as well, and maybe a few others. They think that these athletes are crazy. It is like the people who climb Mount Everest. I usually ask such doctors whether they would refuse to treat a smoker, and that usually resolves the problem. That is my way of handling it. But it is a very good question.

DR. ANDERSSON: I want to continue on the scuba diving, breath-hold diving topic here, and ask Dr. Pollock, are there any statistics on how frequently it happens that people are scuba diving first and then breath-hold diving and being hit by decompression sickness incident or similar?

DR. POLLOCK: We do not have data that addresses your question. We hope this will change, however, as we develop the breath-hold incident database.

DR. ANDERSSON: That is not something that is in traditional DAN database? It would go into the new one?

DR. POLLOCK: There is nothing in the original diving database that captures breath-hold activity surrounding scuba activity. We can capture it in the breath-hold database now but will have to add fields to the original database to capture this information in future cases. Currently and retrospectively, there is no organized capture of that information.

DR. ANDERSSON: I think it is not that infrequent that it happens that people are freediving after scuba diving. There is a good chance that it could happen quite often.

MR. KRACK: Having spent a good part of my diving career in the Caribbean, and Cayman specifically, I think you would see it is very common from scuba divers that they would take their day off before they fly or at least do their dive in the morning and then spend the afternoon freediving, so that they stay within their no-fly window, which necessarily is not as safe, but I think that would probably be a common thing.

MR. LANG: In the science diving community in the United States, with about 4,500 divers, we prohibit it but we do not have a really good reason for telling our scientists who are spending \$25,000 per day for a research vessel why they cannot freedive to collect samples or continue their observations in between the scuba dives. I know it was not presented per se, but what is the rationale behind prohibiting freediving in between scuba dives? Is it an ascent rate issue with a residual nitrogen load that you already have? You come up from your scuba dive, slow ascent, make a stop, come to the surface, drop your tanks, immediately go back down to say 60 or 70 feet and come flying back up to the surfaces. What is the suggestion as to why it is pretty much universally prohibited?

DR. POLLOCK: First, a little perspective regarding the prohibition against freediving during scientific diving activity. I wonder how many divers in the various scientific programs know the rule. I would bet that most would either not know or not give it serious thought in regulating their activity. I do not think that the written prohibition means too much.

Back to the question, I think that one suspicion is that some bubbles trapped in the pulmonary capillary bed could be compressed and pass into systemic arterial circulation if a diver descended, particularly during an energetic descent. The opportunity for this to occur might be very small in terms of time and the number of bubbles affected, but there is a theoretical risk. I do not know of the real practical risk but I think that this is one of the justifications for calls to avoid breath-hold diving when intravascular bubbles may be present.

DR. LUNDGREN: Let us step back for a moment to the question of treatment of decompression cases or suspected decompression cases.

DR. WONG: I just want to comment on breath-hold dives who present with symptoms. Firstly, I do not accept the six-hour window of opportunity. And, Dr. Bennett, I do not think a Table 6 is bad because most of the breath-hold divers dive deeper than 18 m [60 ft]. They dive to 20 or 30 m [66 or 98 ft]. Nitrogen uptake could be substantial over time.

I have treated a couple of divers, one of whom was an accountant. He dived on a weekend. He went to work on the following Monday, and had constitutional symptoms. He had muddled thinking. He could not even do addition. He thought he was getting the flu, a viral infection, all kinds of excuses not to see a doctor. Eventually, his wife took him to see a doctor who knew something about diving medicine who referred him to me. I treated him on the following Friday, days after the six hour 'window of opportunity.' He received a Table 6. He responded after the first 20 min. He was totally clear at the end of the treatment. We gave him one more treatment the following day and he was perfectly okay.

I have also treated another patient successfully in a similar case. I do believe that breath-hold divers who present with symptoms should be treated.

MR. ALAN: I would like to ask the panel members, each from your various perspectives, what you see as an objective subsequent to this symposium. Where do we go from here? And I would like to see that from two different perspectives, an academic perspective and also a pragmatic or practical perspective.

DR. LUNDGREN: Let us save that for wrap-up, it is a pertinent question indeed.

DR. MACRIS: For Dr. Smerz, I just wanted to say my question was when you have ruled out the evidence, you have gone to the emergency room and done the CT scan. But the second point is we are all discussing kind of a newly old phenomenon. I first learned about it two years ago in a publication

in Japan. Most divers do not know about this. And we talked about resistance in the dive magazines. Maybe it is time to come out of the closet about it, so to speak, and put it in the widely read journals about this peculiar syndrome, so that they can begin reporting.

Because people who are on the receiving end of long range air travel like myself, and I am sure Hawaii, picking up, heading out on the 12 hour flights, think divers who have had a clean period post-dive who have maybe done freedives afterwards will report this peculiar feeling. They think they slept funny on the airplane or pinched a nerve and it goes on for days. Perhaps this is, when the general diving community knows more about it, you will hear more reports and it may be much more prevalent than we even thought.

DR. BRUBAKK: First of all, to the question of the scuba dives, scuba dives and the breath-hold dives remind me that the Taravana or these symptoms are only seen after repeated dives with short time intervals. I mean, it is a very sticky situation. My guess would be most divers if they are not competitive, divers training to do a very deep dive, most recreational divers will never dive in that way. So, in practice I do not think that this is a very pertinent problem. I think that it is very rare that you will have someone actually able to build up enough nitrogen or whatever mechanism there is to have something similar to what you see in these breath-hold divers. I think that is very unusual.

The second question, to the bubbles that are supposed to go through the lungs. I think there is a lot of misconception here. We have done studies where we actually looked at dives that had significant amount of gas bubbles in the venous side. When we exercised them very hard, we could not see anything. On the other hand, we know from other studies that very small bubbles that normally stop at the lung, if you do very slight exercise, they will go through. And the mechanism for that is probably an opening of shunts in the lungs. And the exercise that you need to do that is very mild. I think anybody who walks up to the bar that has an oxygen consumption that is such that he will actually open up his vessels to take through the gas, so that happens all the time. So if that is the mechanism, then you would expect everybody to have serious problems.

MR. KRACK: I think if you looked at the wider spearfishing community you would probably see a lot of unreported incidents of decompression illness. Typical spearfishermen work in the 30 ft [10 m] range. They do multiple, very quick, repetitive dives. It would not be unusual over the course of a day to do upwards of 100 freedives, maybe trying to follow a double surface interval rule, although probably more likely following a one-up-one-down pattern. I think if we looked into it further, we would probably see a lot more hits than we realize are out there.

DR. BUTLER: I think the original question was, is it okay for people who are scuba diving who have made a dive, made a presumed surface interval and then are going to make a subsequent scuba dive, is it okay for them to be making freedives down to 60 ft [18 m] multiple times during their surface interval. If that was correctly perceived, I think the answer is that the decompression computer that you are using assumes that you are on the surface doing your surface interval. And so that the – unless, if you were wearing a computer, now, that is an interesting question, presumably, the computer would adjust for that, and you could perhaps do that safely. But if there are tables, they assume that you are at the surface.

MR. LANG: You would violate every ascent rate every existing computer out there doing a free ascent.

DR. BUTLER: Yes, but the ascent rates for scuba dives.

DR. BRUBAKK: I think it was a misunderstanding. I am not saying that it is totally safe. I am just saying that the normal recreational diver would probably not do the kind of breath-hold dives required to have a problem.

I will just make one additional comment. If you are on your scuba dive, if you do a dive that produces a significant amount of vascular gas bubbles, they will stay there for a very, very long time. I have seen bubbles for many hours – long after the time excess gas was expected. They are very resilient. They can stay there for a very long time.

DR. LINDHOLM: I would like to make a comment on the possibility of the nitrogen loading during breath-hold diving. If you do a simple calculation that exists in many computer programs today, you see that you have nitrogen accumulation during profiles of breath-hold dives, repetitive dives. We also know we have a quite substantial diving response with a reduced blood flow to peripheral tissue, skin, muscle, and so on. And if we would look at nitrogen loading as a perfusion rather than a diffusion issue for a while, we could think that we could probably load a substantial amount of nitrogen in the spinal cord, and in the brain. Which means that is where we have a lot of nitrogen, and it would be a sort of specific condition because of the breath-hold diving response that causes us to see mostly neurological DCS and not the joint pains, not get the skin bends, and so on.

DR. RAMASWAMI: Has the panel any recommendations on a suitable interval between breath-hold diving and flying?

DR. POLLOCK: No.

DR. LUNDGREN: The panel is embarrassed to be unable to answer that.

MR. KRACK: I can tell you what we teach is basically to follow the current DAN recommendations, which are for scuba diving.

DR. ANDERSSON: I have to say that after slight exercise you see bubbles going over from the venous side to the arterial side. And, of course, even non-professional, non-elite breath-hold divers exercise while doing snorkeling or freediving. Call it whatever you want. And could have venous bubbles being trapped.

DR. BRUBAKK: But the point is that the exercise needed to have that effect is so small, that actually you could then lie down and not move, which would also be bad.

DR. POLLOCK: I would like to offer a comment for perspective here. We do not know whether bellying up to the bar is going to be enough exercise to initiate right-to-left shunting. But presumably your breath-hold effort will involve a bit more effort. We are speculating. We do not know.

DR. ANDERSSON: That is why I wanted to ask you if there were any statistics. Until we have the statistics, it is pure speculation.

MR. DUNFORD: Do we have any information on the prevalence of decompression sickness in a diver who has done scuba dives, compressed air dives, and freedives on the same day?

DR. POLLOCK: No, we do not. But if you do a Google search. I am sure you can come up with something.

DR. DUNFORD: You can come up with anecdotal data, but the DAN database would be the place to look for it.

DR. POLLOCK: We have not had those fields in place, so we have not captured the data.

DR. YOUNGBLOOD: I would like to point out that we are kind of stuck in some semantics to an extent, and except for one of the panelists I have only heard decompression sickness mentioned, not decompression illness. I do not think we can really exclude that some of these problems we see are due to pulmonary barotrauma. In which case, looking backwards and saying, well this could not possibly be decompression sickness because it was a very short dive. It could be just one dive and it can be in a swimming pool. There is a case like that, as you probably know.

I do think that treatment for suspicious cases is warranted. And I would suggest that since we are dealing with neurological injury, we might consider the work of Holbach in Germany as far as the effect of oxygen on the injured brain. This would support treating with lower oxygen pressures rather than higher ones, since oxygen itself is a highly diffusible gas and can add to the volume of levels in the brain initially.

DR. LUNDGREN: I would like to add a comment inspired by Dr. Youngblood's reference to terminology. Dr. Schagatay posed the question and discussed whether the splenic contractions should be included under the rubric of diving response. Your work in particular has provided the justification for including that in the diving response. The diving response is what we define it to be. There are no preset rules. At one time diving response was just bradycardia, period. Then we came to realize that that was coupled with reduction in cardiac output, vasoconstriction, which might come before the bradycardia, et cetera, et cetera. So I think it is entirely reasonable to see this as one very important response from the body to the breath-hold diving stress.

DR. SCHAGATAY: Let us put it into the diving response. Can we all agree on that? But then the comment do you want to include also the long-term training effect in the diving response, the one-year training effects and so on? Everything is a response to diving. And for quite some number of cases we have defined the diving response as that exactly, vasoconstriction, bradycardia. And now we have discovered that the spleen story has a different time frame, has probably different mechanisms of initiation and so on. And, of course, we can expand the diving response idea, but then I think we have to include a lot more.

DR. LUNDGREN: That might be. As the arguments grow, so does the definition of the diving response. It is a matter of semantics.

DR. LINDHOLM: Racehorses have splenic contractions while running. Well, when you go running, you also have splenic contraction. And we know that during breath holding we have quite substantial vasoconstriction. And the splenic contraction during breath-hold, you had data to show that the asphyxias seem to be important for the splenic contraction. So I would probably lean more towards that that is a phenomenon that can occur or happens during this than rather being a specific triggered event. Because the vasoconstriction and the bradycardia seems to be triggered from a central program in the brain. Scholander called it the master switch, whether you were breathing or not. Basically, the normal reaction to hypoxia if you are not breathing is bradycardia and vasoconstriction. That is what happens when you are a fetus in the womb (it has been shown in animal studies). While, if you breathe, the increased breathing rate will also drive up the heart rate if you go high altitude, for example.

So I am not so sure that it is an active part of the diving response. It could very well be something different that happens with the stress of breath holding and then cause the effect of the spleen that we also see during other types of exercise or stressful situations.

DR. SCHAGATAY: I agree that you can have a spleen response in many different circumstances where it is not likely that you have diving response, if we stick with the old definition of the diving response. I think it is easier to have more definite terms also than including too much in one definition.

DR. ANDERSSON: Going into the past, we also did not say the term diving response. We said diving reflex. And, of course, the diving reflex was expanded to diving response to acknowledge that there were several reflexes involved combining into one diving response. So, it could be that the splenic reflex, response, is part of the diving response, but not the classical diving reflex consisting of bradycardia and vasoconstriction. Any comment?

DR. SCHAGATAY: I think diving reflex and diving response are synonyms. They have been used – the classical definition is diving reflex and at least 30% today and yesterday have used diving reflex and the others diving response. I think in the mid 1980s, it was switched to being the major term diving response. That is semantics, I think. But then we have to agree where is the line between what we are studying. And I think also the outcome of the different adjustments is very essential to deciding whether it should be treated as one response.

I think it is the time frame of the response that is actually most interesting, the difference between the time frames. Because you have three different time frames for responses. You have the very acute, direct diving response, classical one. You have spleen response. There might be other responses that we do not know yet. And then you have the long-term training effects. And they are all responses to apneic diving.

DR. LUNDGREN: And I suppose it gets down to fine points, it becomes somewhat like discussing whether high-altitude polycythemia is a hypoxic response or not. Takes time for it to develop, but it is certainly triggered by hypoxia.

DR. DUEKER. There is a good reason not to call it a diving reflex. Because the reflex is a mechanism that can be defined and so it is much more complicated. Diving response bothers me a little bit because some of it does not even require diving. But at least it is much more accurate than calling it a diving reflex.

DR. SOUTHERLAND: We were talking about definitions. Can you define deep dive? I work at a training command where we teach divers, and some of these divers come up and they may have high CO₂ levels, and we do not routinely throw everybody into the chamber if they have got some sort of cognitive deficits for a few minutes. You are setting up standard of care. We want to err on the side of caution.

But typically in our case when we throw a guy in the chamber as a student, their career as a Navy diver is terminated for two years. So we tend to be a little bit more cautious about putting people in and calling it decompression sickness. Granted, most of our guys are not using breath-hold diving. Some of them end up breath-hold diving because they are very anxious and they go underwater and forget to breathe while they are waiting for the instructor to come down.

And then a comment is, we are talking about thoracic changes during breath-hold dives. Is there such a thing as lymphatic engorgement that could happen? And if so, could that explain some of the hematocrit problems that you see?

DR. LINDHOLM: Well, we still have the issue that you could have an arterial gas embolism from breath-hold diving. We have discussed that some divers pack air into the lungs via glossopharyngeal insufflation. Then at depth there is the blood shift. If you start with a lung volume of say 10 liters and you are compressed at the bottom to squeeze volume so you only have maybe a half liter or one liter of air at the bottom, you have a blood shift of a liter, and then on going up you may have a substantial amount of atelectasis and you also have quite a lot of extra air in your lungs because you packed a couple of liters extra before you started. If you would just hold that volume at the surface, you would pass out from the packing blackout. So you could have sort of an overexpansion issue even from breath-hold diving surfacing from a deep breath-hold dive. If someone comes up with immediate problems, I believe it is definitely a possibility that they could have a cerebral arterial gas embolism from a pulmonary barotrauma. It is a possibility that we need to consider.

MR. KRACK: I want to address the idea of the terminology of a deep dive. In static apnea we talk about a target or a working static. For us a working static means any day not having done any training in the prior days to it. But any day as long as we ate properly when we were supposed to and we got a good warm-up, what could we pull off. Let us say for some of us that might be four minutes. And then weeks later with continuous training we might be hitting six, seven minutes, but our working static is four. I would suggest that the term deep diving is still going to be relative to the person, but we look at it in the same way. Without having done any previous training over the past, you know, weeks, working up to it, and with relative – what could you pull off in one dive without having to do a number of warm-ups to get there.

And, again, that is a relative term. I can do 40 to 50 m [131 to 164 ft] in just one dive with no warm-ups. I brought up some blood too on some of those. But it gives you the idea of where we are coming from on this. For some people that is a 10 m [33 ft] dive. Martin could pull off a 70 m [230 ft] dive having done nothing. Mandy could be doing a 50-60 m [164-197 ft] dive having done nothing for months prior.

DR. ANDERSSON: I have a comment on what you just said on the overexpansion on the lungs on the ascent. There is also a report that diving response, diving reflex could involve the bronchoconstriction, reducing the volume of the conducting airway. And, of course, upon ascent if the conducting airways has a smaller volume, that would mean that the respiratory airways would have to accumulate a larger volume of air possibly leading to overdistention of the alveoli and a rupture of the alveoli and air embolism. I do not know if that is a possibility or if the panel could consider that as a possibility.

DR. LINDHOLM: It is an interesting study. It was Muktar and Patrick, I think. What they did was they put their face in cold water and they measured expiratory volumes just after, within a couple seconds. The breath-holds were just 10 or 15 s, very short. And I do not think that has been studied further.

In the work that I presented this morning we measured the forced expiratory volumes, and we did those measurements after a little while. We measured diffusion capacity first. So it is uncertain whether the immediate vagal effect studied by Muktar and Patrick had any effect.

DR. ANDERSSON: We see similar things in skiers, exercising outdoors in cold weather, having cold wind in their face, having asthma like symptoms, possibly pointing out that there is a bronchoconstriction. So I think it is a likely reaction or possible reflex.

DR. SCHAGATAY: One comment. I think it is likely to find a very strong response like that in children. We are actually doing a study on infants now from 1 to 13 months of age. And just cold stimulation on the forehead gives a quite remarkable response like that.

DR. MULLER: I have a question on the frequency. It was mentioned yesterday, I think a static apnea study, and individual who had persisting neurologic symptoms for 30 min. I have seen it twice in rebreather failures. This is not decompression illness in a static apnea individual. It is obviously a hypoxic injury. How common is persisting neurologic symptoms that we think is from hypoxia and not possibly decompression illness and whether those are folks that people would treat in the chamber.

MR. KRACK: Yes. I have never really seen persistent symptoms other than the immediate ones.

DR. LINDHOLM: Me neither. I think the study you referred to yesterday, that was deep diving as well, the visual disturbance for 30 min. Had he only done a static?

MS. RIDGWAY: He dived the day before, but that day it was a static.

DR. LINDHOLM: I have personally seen quite a few loss of motor controls and blackouts, but I have never seen anything that did not resolve within say 20 to 30 s if you are talking static apneas, but I have only seen maybe 50 incidents.

DR. BUTLER: Dr. Muller, what symptoms did you see that persisted for 30 min?

DR. MULLER: My case actually persisted for three hours. It was almost a complete loss of visual acuity, significant cerebellar symptoms and no working memory that lasted for seven days. Again, it was a hypoxic or this was a failure so it was somebody that we knew was hypoxic and then was essentially recovered manually, apneic and a fair amount of barotrauma as well. In that individual, it persisted a long time.

Paul Sheffield is an individual in the Air Force who I think a lot of you know. He has two cases in the literature, aviators with sudden loss of oxygen supply who had persistent neurologic symptoms for three to four hours. He actually treated both and saw improvement in both.

DR. BUTLER: What I think you are looking at is hyperbaric oxygen appropriate for a post-hypoxic encephalopathy. That is a totally different question than we were looking at with the deep breath-hold divers.

MR. KRACK: Again to give you an experience where a diver went out on us pretty deep. Upon bringing him to the surface, he recovered. It was a long blackout. Within about a minute, he had come around, and then said that he could not see. I started going through neurologics in the water with him, wiggle your toes, things like that. Everything was fine, but he could not see for a couple of minutes. Then he could see, but in black and white and gray colors. We were very concerned about the extended hypoxic exposure. Then we realized that the whole time he was blacked out, his eyes were open staring at the sun.

MS. RIDGWAY: I said 30 min because I was only aware of the 30 min. He was taken off to a medical facility for checking. I do not know whether he went to a hospital. But I think I said yesterday he was functionally blind, which suggests to me a cortical blindness more than a retinal or eye level problem. And I say that because I do not think he lost consciousness at all. Although I did not see the incident. But he, I believe, had a samba. And then walked pretty well unassisted to the side of the pool, climbed the stairs, and then somebody else recognized that there was something wrong with him. I think the judges had recognized the samba so he was disqualified. But it was only at the point that he arrived at the top of the stairs that somebody else came to his assistance, as I remember it. And that suggests to me a functional cortical blindness where you can see, but you cannot perceive that you are seeing.

DR. MULLER. I agree. I think the posterior circulation territories are what we were interested in, cerebellar.

MS. RIDGWAY: I have a selfish question. This is for a discussion in chapter 8 of my dissertation. I would like a panel of biologists and physiologists to give me your best explanation of why I saw a decrement in the cognitive performance on divers after the dive but not after the static. Now, the dive is a shorter duration of apnea, a static is a much longer duration of apnea. What is it about that exercise condition that might have lead to a performance decrement on that complex motor task?

DR. POLLOCK: Please start by sharing your ideas.

MS. RIDGWAY: There are some obvious ones, like it could have been anxiety. Some of the divers had not performed this task before. It was the first day of competition. So anxiety related to those. Anxiety can reduce the scores on neuropsych tests. But then it should have been across tasks, but it only showed up on the one task, not the reaction time. It could be, and again, I am just reading with a very novice mind about a buildup of CO₂ influencing your ability for fine motor control, so after a dive is it just CO₂ that is impairing the motor performance and so they cannot write the symbols as fast? Was it that they have more oxygen, higher oxygen use, and is it a general sort of cognitive and motor decline?

DR. LINDHOLM: I have one theory for you, just a little one. And that is that I believe many divers find that constant weight dives is the most important discipline. That is where you compete. So there might have been a higher stress level in those deep dives. While static, for some divers they just do it because they have to, because it is part of the team competition. Or at least I think personally the safety issue in static, while not very much can happen, you can pass out, but that is not very dangerous in static because your friend just pulls you up. But you can have other issues in the deep dives. I do not know if people are scared of sharks or alligators, but there is certainly more stress going on. You are the neuropsychologist. Do you know if there is stress?

MS. RIDGWAY: In my clinical work I have to make sure the person is not stressed before they undergo testing because we do not know how stress affects.

MR. KRACK: I think the big difference between static and constant, in constant you are certainly going through a lack of threshold. There is that aspect of it, where static you are not. Static dynamic, we come to the surface with legs on fire at times. So there is that physiological stress there.

MS. RIDGWAY: So the lactic acid accumulation is not just in the legs but hands as well, such that it will contribute to poor fine motor performance? I think there is some evidence in high altitude and a few other things as well.

MR. STEPANEK: The only thing that came across my mind is a very similar with what Dr. Lindholm had mentioned, that most competitors put more emphasis on the constant, therefore, they are more stressed out about that. Plus, you gather these measurements during a competition. Static performance is the last one. When you finish with static, everything is done. You do not need to be apprehensive about any other performance, about anything else. So there is a great deal of relief and the competition is over. You know how you placed. I do not know how important a role that plays.

MS. RIDGWAY: So are we saying that it is most likely to be stress? In terms of some individuals in three standard deviations change from their baseline, stress might account for some change, but not three standard deviations. Are we saying that my results are in doubt?

MR. KRACK: I think Mr. Stepanek keyed on an important thing, that static events are traditionally held at the end of a competition. The way to check your data is to have static done in the beginning.

MS. RIDGWAY: I am sure that would be good.

MS. CRUICKSHANK: I know the competition you are talking about. I was extremely nervous about my constant ballast dive, more than I have been on any other dive that I have done because of what I announced in it, and then finding out where I was in the rankings with everybody else. So I know beforehand I was extremely nervous. Afterwards, I was not. Whereas static, you can come up whenever you want. Your announcement can be quite a bit different from your actual performance with no problem so there is much less stress.

DR. LINDHOLM: I would like to ask the experts on decompression sickness in the auditorium to comment. Could there be some effect that you are more tired because of decompression stress? I think Dr. Wong mentioned that some of the divers he had interviewed who were oxygen breathing at the end of the day felt more recuperated after that. And I know that Mr. Stepanek and Ms. Cruickshank feel that they recover better if they do a bit of oxygen breathing after a deep dive. You can speculate that it affects lactic acid and other kinds of recovery, but what you could say is that you could have some decompression stress that makes you tired. There are inflammatory processes involved.

DR. BRUBAKK: The answer is yes.

MS. RIDGWAY: Interestingly, we talked about hidden cameras being selectively more valuable. Probably, I cannot remember how many, but up to about 10 of the divers who had completed the baseline assessment and then completed the same dive assessment, so they were familiar with the task, that helps with anxiety, they knew me, most of that stress should have been reduced, other than the stress of competition. But they self-reported immediately after doing that second dive attempt at the task, they said, oh, my God, this is so much harder now because I have to look up each time. I cannot remember the digits anymore. Whereas on the baseline, once you get memory for a couple of those digits and symbol pairs, you do not have to look up and scan anymore. They regularly said to me, I have to look up each time I do it now. So that will account for a significant increase because you have to scan every time.

DR. LUNDGREN: I think you are speculating a little bit. Ms. Ridgway, was the question whether there is a difference in terms of hypoxia exposure between the two types of dives? Until we have real-time continuous recording of the arterial PO₂ in the two types of dives, it is at least reasonable to say it could well be that with the constant weight dive there is a very rapid fall in the oxygen as you ascend to the surface. By contrast, in the static situation the fall is likely to be much slower so that the slug of arterial blood that hits the brain towards the end of the ascent has a very different oxygen

profile in it than the blood going to the brain towards the end of the static apnea. And who knows what that does. I do not believe the two events are comparable from the point of exposure to hypoxia.

MS. RIDGWAY: Thank you. And I did make some recommendations about how long it would be until you should drive a motor vehicle or something. I probably stand by that cautiously now because it was widespread. It was every individual who had pretty close to that three standard deviations decrement. Thank you.

DR. LINDHOLM: For your discussion in your dissertation, you should add hyperoxia as well. Dr. Muth has shown in 20 m [66 ft] chamber dives that you are getting quite substantial hyperoxia in breath-hold diving. What we get in 60-70 m [197-230 ft] dives in the competition you studied, we do not know because we do not know how well the gas exchange work in the lungs work due to the squeeze. But we can certainly say that we probably have hyperoxic provocation as well.

MS. RIDGWAY: What is the duration of the hyperoxia?

DR. MUTH: The whole dives lasted four to five minutes, and the very high oxygen partial pressure was for two to three minutes on the bottom time. By ascending, there was, as Dr. Lundgren said, a very, very rapid fall from PO₂ values two and a half times higher than normal to 28 mm Hg at the surface, from hyperoxia to hypoxia very rapidly.

MS. RIDGWAY: I am testing it five minutes afterwards, does that affect?

DR. MUTH: We do not know how long it lasts.

DR. MACRIS: We have discussed sambas and mooglies and Tarvanas and all these. I think at least the first two are clearly hypoxic. Can the panel come up with a terminology we can begin to use for these breath-hold diving neurological deficits which are persisting, some initial description that we could use so that when we start talking about this, we are talking about the same thing. The ones that persist, and the ones for which we do not know what the causes are. So maybe in the spirit of a workshop we can give a name to the disease.

DR. SCHAGATAY. It is probably good to have as a basis the terminology from the divers themselves. Because what they talk about is what is there. And then we have to define what its cause is, of course. I think the main problem here is that there is a scientific community and there is a diving community. In a meeting like this, the strength is that we can talk to each other.

I would like to ask the divers a question. What would be your wish list for things to research? What would be the top three questions that you think we should address?

MR. KRACK: We have always said our top two are lung squeeze and decompression illness.

MS. CRUICKSHANK: Long-term effects, if there are long-term neurological effects to freediving. That is one of the top questions people ask us.

MR. KRACK. There is going to be a wish list. Now you have got us thinking. Recovery breathing, three packs or packing, one long hold, hold for two seconds at the top, that sort of thing.

DR. MACRIS: Do we call it breath-hold diving neurological deficit? We cannot call it decompression illness yet. What can we call this when we talk to one another from this point on? I am looking

towards the panel to describe the syndrome. The one that people say cannot be decompression illness but we know is happening.

DR. BUTLER: Let us make another list then. I think we have heard post-hypoxic encephalopathy as one. I think we certainly acknowledge that there could be pulmonary barotrauma with cerebral gas embolism is two. And decompression sickness is a third. I do not know if there is anything else on the table besides those three entities.

DR. MACRIS: But one that we clearly know, decompression illness, traditionally could associate with a compressed air diving. This is a new phenomenon. Maybe there is one other than Taravana, whatever the term was. What can we use scientifically to begin to describe this when we talk about it?

DR. BUTLER: I think it is certainly fair to recognize that different types of decompression stress can present with different decompression syndromes. And I am thinking of sometimes the inner ear hits that the saturation divers get is fairly unique to that type of diving. When we would do experimental dives at the Experimental Diving Unit [EDU; in Panama City, FL], when we would see things that presented right after the dive, they were often neurological hits. If they came in the next day, they were typically the joint pains and less emergent things.

There was a difference also when we would do nitrogen dives versus helium dives. Dr. Ed Thalmann described this years ago. The bends that we saw from our heliox bounce diving were pretty significantly worse than the bends we saw from our nitrox diving. So I think what we may have here is decompression sickness, but just that subset of decompression sickness specifically caused by this type of diving.

UNIDENTIFIED SPEAKER: Breath-hold diving decompression sickness, I will go with that.

MS. RIDGWAY: I would disagree that we need to give it a name that suggests the cause and bring up something that someone said before. We do not know what the cause is yet. Let us be objective and describe the behavioral symptoms that we see. The way I got around it from my writing is negative neurological events. I think we all agree that it covers something to do with neurology. That is a bit too generic, obviously, for the scientific community, but I think we run a risk if we start giving it a name that implies a cause.

DR. LUNDGREN: There is some merit to what Dr. Macris just suggested - breath-hold diving neurological deficit - and it satisfies our love for acronyms. BHDND. That says nothing about the etiology, which we all can agree we do not know about, but it is a way to describe something that is linked to breath-hold diving, which we are here about, and it shows up as a neurological deficit.

DR. LINDHOLM: I think we can, academically, discuss different terms and have different terminology and working hypotheses, but if we are going to treat any patient, if we look for a moment that we are treating divers at a chamber and we have someone coming in with those neurological symptoms that are classic symptoms for a neurological decompression hit, except that they did not scuba dive. I do not know how you do in your country, but you all need codes for the hospital administration, to be able to treat people. So if you are going to come up with a new name and you are going to process that through your government, insurance company, et cetera. I think from a practical point of view, I would probably classify it as neurological decompression sickness and treat them, and then have other terminology on our medical conferences and discuss whether we can come up with, if there are any leads, something different on this issue.

DR. BUTLER: I agree with that.

DR. FOTHERGILL: This is an open question to the panel. With the extreme deficit we are seeing in competitive breath-hold diving and the very quick descent rates, are we about to see our first evidence of a CNS oxygen hit at depth?

DR. LINDHOLM: That is a very interesting speculation.

DR. BUTLER: There is a latent period with oxygen toxicity. I guess the question is whether or not the latent period would be offset by the decrease in the oxygen content in the diver's blood as he or she consumed oxygen. I think it is a distinct possibility at great depths if you stayed down there for significant time.

We really did not test any depths below 50 ft [15 m] for oxygen toxicity at the Experimental Diving Unit when we were doing those studies. The time at the 50 ft [15 m] depth was 10 min. I do not know if there is good data to extrapolate to greater depths for that type of oxygen toxicity.

DR. KAY: In the interest of discussion, why not call this in honor of the late E.R. Cross, why do not we call it Taravana until we know the mechanism. Once the mechanism is elucidated, then we can call it neurological whatever.

DR. BENNETT: I would like to come back to Dr. Butler's oxygen toxicity issue. When I was working with the Royal Navy, we did some studies with rats. We were interested in submarine escape, which is the same kind of thing I mentioned earlier, 400 or 500 narcosis studies. And in the rats we were compressing around 400 to 600 ft [122 to 183 m]. Travel at 100 ft [30 m] per minute. The times are not quite where we are with breath-hold diving.

But then we got out. We said, okay, that is great. There were no convulsions on the bottom. They did, though, convulse on the surface, indicating that the toxicity level required a little time for the biochemistry to catch up. So it can happen. I think the times, from my experience and memory, are a little bit too short yet in the breath-hold. If we can keep going deeper, though, we are going to get right in the range.

DR. MUTH: I just made a quick calculation, and the deepest dive I know about was the record attempt of Patrick Musimu who reached 209 m [686 ft], which is roughly 20 atmospheres. And as he raised air, he had a partial pressure of 0.2 atmospheres of oxygen at surface. That is roughly 4 atmospheres in 209 m [686 ft]. And I know his dive profile. He spent a little more than 45 s in this depth. The whole dive lasted roughly three and a half minutes. I do not think that this is enough to make oxygen toxicity of the brain coming up.

DR. LUNDGREN: In addition, if oxygen is really going to go into the blood in this pushed-together pair of lungs to the extent where it could raise arterial oxygen tension in the brain enough, nitrogen would also be there. And as I believe Dr. Bennett has shown, nitrogen narcosis counteracts oxygen toxicity, seen as oxygen convulsions.

DR. BUTLER: We also have CO₂ buildup, which is a known potentiator of oxygen toxicity.

DR. MUTH: I forgot to say that we measured blood gases, not in 200 m [656 ft] but in 20 m [66 ft] in a breath-hold dive. What we could not find was an increase of the PCO₂ in the arterial blood. The arterial oxygen pressure rose but not as you would predict by calculation. If you go from zero to 20 m x3 for the pressure effect, the oxygen partial pressure should also rise by x3, but it could also be roughly 2.4. This is a blood shift. We have an enormous increase of the pulmonary shunt fraction. So what would go into the arterial side will be mixed venous blood, venous blood and arterial blood, so

that the real PO₂ in the brain will even be less than this three atmospheres, very likely. There was this clear-cut effect of high shunt fraction rise in the partial oxygen pressure, but no CO₂ pressure.

I do not believe that the CO₂ plays a major role in this question. And the oxygen is not the real problem. We have real problems with nitrogen, I am truly convinced, but not oxygen or CO₂.

DR. BENNETT: I am not going to debate the nitrogen question again. Let us get back to oxygen. Just think what we are doing. We are hearing about 45 s at 600 ft [183 m]. But you also have a great deal of travel time. That should be taken into consideration, and it is more than 45 s.

DR. BUTLER: To follow-up on Dr. Bennett's observations, it is possible that if there are seizure events on the surface, that some of these seizure events could have been the onset of oxygen toxicity that started deep and proceeded into an O₂ hit. There is lots of data on people who have had an oxygen exposure, terminated the oxygen exposure and had a seizure after they discontinued breathing oxygen. So whether or not that is something that comes into play, it is hard to know.

But one thing we can say for sure as we listen to the experiences of the breath-hold divers, we have not heard anybody describe a convulsion on the bottom. We have not heard anybody describe significant, major motor muscle twitching on the bottom. So those are the type of symptoms that we saw at the Experimental Diving Unit with oxygen exposures, and they do not seem to be happening at depth.

DR. LUNDGREN: Thank you very much. We are coming up on five o'clock, and it is time to begin our wrap up.

DR. POLLOCK: We have an open question from Mr. Alan from early in the discussion - where to from here. I know I have an interest. These workshops are wonderful venues to share views, identify outstanding questions, and better define the separation between speculation and knowledge. For me, the most important next step is to refine and accelerate the data collection, specifically for my interest the incident data. We need to know what is happening and what factors are playing a role. We need to understand what is going on with both the successful and the unsuccessful exposures.

DR. LINDHOLM: I would agree with Kirk Krack's two suggestions on the most interesting research fields right now. Decompression issues for the breath-hold diving and pulmonary squeeze. There are a lot of divers spitting blood when they come up. We have not discussed that very much here today because there are so few data to consider. I also think we had more expertise in decompression among the attendees of this symposium. But it would be interesting to see more research on both questions in the future.

DR. LUNDGREN: As we close this, let me say at the outset that I am not going to give a complete review of everything that is been said. I will not expose you to that. You all have your foci of interest, which may differ quite a lot. So when you go home and what you take with you depends on that and what you have learned here today.

I think I can speak for everybody, and we can pat our collective back, for a very vigorous and very exciting meeting. If there is one thing this workshop has done much more than earlier meetings, and it is really a positive thing, it has fostered the interaction between those of you who are out in the field practicing breath-hold diving and us who are primarily back in the labs trying to keep pace with you.

And that brings me again back to what I started out earlier saying, namely, that as the history of breath-hold diving in recent times has shown, researchers have, to a large extent, been behind the

moving front of what is happening in the field. There is potentially one undesirable outcome of that. And that is that the divers out in the field may have a tendency to thumb their noses at the researchers, and for understandable reasons. Because here we were not too long ago suggesting that the limit for deep breath-hold diving was set by the compression ratio between the largest volume you could keep in your lungs after deep inhalation and the residual volume obtained from standard pulmonary function tables. And that predicted limit was 40-50 m [131-164 ft], period.

Well, we know where we are. And again, the reason those limits were set in the predictions, is that it was the best information that science had at the time. And the recommendations that were given based on that stemmed from the fact that the physician's role is to try and always give advice that is not likely to cause hurt to the patient or, in this case, the healthy breath-hold diver.

In contrast, competitive athletes, as many of you who practice this art certainly are, are not going to sit for anything less than the absolute extreme that can be done. And in so doing, discover how absolutely wrong those limits were.

On the other hand, it has been predicted and substantiated by field observations that chest squeeze can cause pulmonary vascular rupture and bleeding into the lungs. That was kind of ignored in the diving field, but it is true.

I hope we can come together. I certainly have gained a tremendous amount of respect for our diving friends for certainly their bravery but also their observations and the very serious way in which the responsible persons in the field go about their sport. I hope this will lead to more interchange of the kind that we have had here, and that good persons can think about ways to spread the gospel in the written form. And Dr. Bennett mentioned before that perhaps we could see ways that we could get the trade journals to be more responsive to what we have to offer. I think that is extremely important. Because only when the interest of the diving community is raised, and a self interest it should be, then is what we are trying to do in the labs really going to benefit the end user.

Thank you all for participating.

(Symposium adjourned)

APPENDIX A - List of Acronyms Used

AIDA	Association for the International Development of Apnea
ARDS	Adult respiratory distress syndrome
ATA	Atmosphere absolute
BH	Breath-hold
BHDND	Breath-hold diving neurological deficit
BMI	Body mass index
CNS	Central nervous system
CO ₂	Carbon dioxide
CPAP	Continuous positive airway pressure
CT	Computed tomography
DAN	Divers Alert Network
DCI	Decompression illness
DCS	Decompression sickness
EDU	Experimental Diving Unit
ECG	Electrocardiogram
EEG	Electroencephalogram
ENT	Ears, nose and throat (physician specialty)
ETBV	Extrathoracic blood volume
FRC	Functional residual capacity
GE	Glossopharyngeal exsufflation
GI	Glossopharyngeal insufflation (or lung packing)
Hb	Hemoglobin
Hct	Hematocrit
HPNS	High pressure nervous syndrome
IQ	Intelligence quotient
ITBV	Intrathoracic blood volume
LMC	Loss of motor control
LOC	Loss of consciousness
MEG	Magnetoencephalography
MRI	Magnetic resonance imaging
N ₂	Nitrogen
NNE	Negative neurological event
NOAA	National Oceanic and Atmospheric Administration
O ₂	Oxygen
P _a O ₂	Partial pressure of arterial oxygen
P _A O ₂	Partial pressure of alveolar oxygen
PBT	Pulmonary barotrauma
PCO ₂	Partial pressure of carbon dioxide
PET	Positron emission tomography
PN ₂	Partial pressure of nitrogen
PO ₂	Partial pressure of oxygen
RER	Respiratory exchange ratio
RV	Residual volume
SEAL	Sea, Air and Land (U.S. military special forces personnel)
SIPE	Swimming-induced pulmonary edema
SDMT	Symbol digit modalities test
SPECT	Single photon emission computed tomography
S _a O ₂	Arterial oxygen saturation
S _p O ₂	Arterial oxygen saturation (measured by pulse oximetry)
SWB	Shallow water blackout
TPA	Tissue plasminogen activator
UHMS	Undersea Hyperbaric Medical Society
WESS	Web-enabled safety system

APPENDIX B

Workshop Participants

Mark Alan
Fort Lauderdale, FL, USA

Johan PA Andersson PhD
Lund University
Lund, Sweden
johan.andersson@cob.lu.se

Charles R. Auker, MD, PhD
Reston, VA, USA
aukerc@nmrc.navy.mil

Peter B. Bennett, PhD
Duke Univ. Med. Center/International DAN
Durham, NC, USA
peter.bennett@duke.edu

Onno W. Boonstra, MD
Rotterdam, Zuid-Holland, Netherlands
surgeon@ruygheboontjes.demon.nl

Alf O. Brubakk, MD, PhD
Trondheim, ST, Norway
alfb@ntnu.no

John M. Buchanan, MB, ChB
St. Martinus University
Willemstad, Curacao, Netherland Antilles

CAPT Frank K. Butler
United States Special Operations Command
Pensacola, FL, USA

Robert W. Carter
Great Lakes, IL, USA

Robert J. Chaskes, DO, CWS
North Miami Beach, FL, USA
drchaskes@yahoo.com

Tec Clark BS
Fort Lauderdale, FL, USA
tec@scubaguru.com

Jonathan L. Conard, DO
Durham, NC, USA
jonathanlconard@yahoo.com

Robert C. Cook, MD
Severna Park, MD, USA
ccook@toad.net

Mandy-Rae Cruickshank
Performance Freediving
Vancouver, BC, Canada
Mandy-Rae@performancefreediving.com

Michael D. Curley, PhD
Durham, NC, USA
mcurley7@comcast.net

Guy deL Dear, MB, FRCA
Duke University Medical Center
Durham, NC, USA
guydear@hotmail.com

Sacha M. Dench
Sydney, New South Wales, Australia
sacha@sachadench.com

David J. Doolette, PhD
Navy Experimental Diving Unit
Panama City, FL, USA
david.doolette.as@navy.mil

Christopher W. Dueker, MD
Atherton, CA, USA
ChrisDuek@aol.com

Richard G. Dunford, MS
Virginia Mason Medical Center
Seattle, WA, USA

Frank P. Farm, Jr.
University of Hawaii
Honolulu, HI, USA
farm@htchawaii.com

John R. Feiner, MD
San Francisco, CA, USA
feinerj@anesthesia.ucsf.edu

David M. Fothergill, PhD
Navy Submarine Medical Research Laboratory
Groton, CT, USA
fothergill@nsmrl.navy.mil

John J. Freiburger, MD
Duke University Medical Center
Durham, NC, USA
jfreiberger@dan.duke.edu

Larry S. Garsha, MD
Arlington, VA, USA
larrygarsha@comcast.net

Craig A. Gentry
FPO, FL, USA
truepatriot1776@yahoo.com

Renie R. Guilliod MD
University of Texas
Houston, TX, USA
renie.guilliod@uth.tmc.edu

R. William Hamilton, PhD
Hamilton Research, Ltd.
Tarrytown, NY, USA
rwh@rwHamilton.com

Karl E. Huggins, MS
USC Catalina Hyperbaric Chamber
Avalon, CA, USA
huggins@usc.edu

Edmond Kay, MD
Seattle, WA, USA
ekay@u.washington.edu

Kiyotaka Kohshi, MD
Kitakyushu, Fukuoka, Japan
k-kohshi@clnc.uoeh-u.ac.jp

Kirk Krack
Performance Freediving
Vancouver, BC, Canada
kirk.krack@performancefreediving.com

Michael A. Lang, BS
Smithsonian Institution
Washington, DC, USA
langm@si.edu

Charles E. Lehner, PhD
University of Wisconsin-Madison
Madison, WI, USA
sobakin@wisc.edu

John E. Lewis, PhD
Rancho Palos Verdes, CA, USA
jlewis007@earthlink.net

Peter Lindholm, MD, PhD
Swedish Defence Research Agency
Centre for Environmental Physiology
Karolinska Institutet, Stockholm, Sweden
peter.lindholm@ki.se

Mats H. Linér MD, PhD
Lund University Hospital
Lund, Sweden
mats.liner@skane.se

Edwin T. Long
Poulsbo, WA, USA

Claes E.G. Lundgren, MD, PhD
Center for Research and Education in Special
Environments,
State University of New York at Buffalo

Robert G. Lutan
University City, MO, USA

Terry L. Maas, DDS, MBA
Ventura, CA, USA
tmaas@west.net

George P. Macris, MD
Guam
georgemacris@usa.net

Anthony J. Medak
San Diego, CA, USA

Melton
Navy Experimental Diving Unit
Panama City, FL, USA

Sheila J. Modi, BS
University of Texas Medical Branch
Galveston, TX, USA
sjmodi@utmb.edu

Matthew S. Muller
Mount Pleasant, SC, USA

Claus-Martin Muth, MD
Senden, Germany
CMMuth@aol.com

Hirofumi Oiwa, MD, PhD
Yokohama, Kanazawa-ku, Japan
oiwa@amy.hi-ho.ne.jp

Dan Orr, MS
Divers Alert Network
Durham, NC, USA
dorr@dan.duke.edu

Neal W. Pollock, PhD
Duke Univ. Medical Ctr./Divers Alert Network
Durham, NC, USA
neal.pollock@duke.edu

Ralph T. Potkin, MD
Beverly Hills Center for Hyperbaric Medicine
Los Angeles, CA, USA
potkinr@aol.com

Ravi Ramaswami, MD
Department of Underwater Medicine
Institute of Naval Medicine
Alverstoke, UK

Lynne Ridgway, PhD cand
University of Queensland
Shorncliffe, Queensland, Australia
lynne@psy.uq.edu.au

Jan Risberg, MD
Norwegian Underwater Institute
Bergen, Norway
jri@nui.no

Erika Schagatay, PhD
Department of Natural and Environmental Sciences
Mid Sweden University, Sundsvall
Sweden

Erik S. Shank, MD
Winchester, MA, USA
eshank@partners.org

Jeffrey Sipsey

Richard W. Smerz, DO
University of Hawaii
Honolulu, HI, USA
rsmerz@htchawaii.com

Leonard Smith, MD
FL, USA

Aleksey S. Sobakin PhD
University of Wisconsin-Madison
Madison, WI, USA
sobakin@wisc.edu

David G. Southerland, MD
Naval Diving and Salvage Training Center
Panama City, FL, USA
david.southerland@navy.mil

Martin Stepanek
Performance Freediving
Fort Lauderdale, FL, USA
Martin.stepanek@performancefreediving.com

Bret W. Stolp, MD, PhD
Duke University Medical Center
Durham, NC, USA
stolp002@mac.com

Tanya Streeter
Austin, TX, USA

Alexis Tabah, MD
Paris, France
buy@tabah.com

Seiichiro Togawa
Tokyo Medical and Dental University
Tokyo, Japan

Stephane D. Tremblay, MD
Hotel-Dieu de Levis Hospital
Levis, Quebec, Canada
sdtremblay@videotron.ca

Donna M. Uguccione, MS
Divers Alert Network
Durham, NC, USA
duguccioni@dan.duke.edu

Robert van Hulst
Schagen, Noord Holland, Netherlands
ravhulst@planet.nl

Richard D. Vann, PhD
Duke Univ. Medical Ctr./Divers Alert Network
Durham, NC, USA
rvann@dan.duke.edu

Johnny J. Vazquez
Mayo Clinic
Rochester, MN, USA

Dan E. Warkander, PhD
Navy Experimental Diving Unit
Panama City, FL, USA
WarkanderDE@nedu.navsea.navy.mil

John J. Wassel, MD
Concord, NC, USA
wassdive@yahoo.com

Robert M. Wong, MB, FANZCA
Fremantle Hospital
Fremantle, Western Australia, Australia
robert.wong@health.wa.gov.au

Kazuyoshi Yagishita
Tokyo Medical and Dental University
Tokyo, Japan

David A. Youngblood, MD
Haleiwa, HI, USA
nradoc@yahoo.com

APPENDIX C
UHMS/DAN Breath-Hold Diving Workshop Schedule
June 20-21, 2006 - Orlando, FL

Time	Duration	Presentation	Presenter
0800-0810	:10	Opening remarks	Lundgren, Lindholm
Session A		Moderators: Lindholm/Lundgren	
0815-0915	1:00	The science of breath-hold diving: past, present and future	Lundgren
0915-1010	:55	Nitrogen narcosis during No Limits freediving world record dive to 160 m (525 ft)	Streeter
1010-1030	:20	Break / Informal Discussion	
1030-1130	1:00	Physiological mechanisms involved in the risk of loss of consciousness during breath-hold diving	Lindholm
1130-1145	:15	Increased levels of the brain damage marker S100B after apneas in competitive breath-hold divers	Andersson
1145-1200	:15	'Sambas,' 'Mooglies,' and other acute effects of apnea	Ridgway
1200-1215	:15	Apnea divers: hypoxophiliacs, athletes, or valuable medical research subjects?	Ridgway
1215-1330		Lunch	
Session B		Moderators: Pollock/Butler	
1330-1430	1:00	Development of the DAN breath-hold incident database	Pollock
1430-1445	:15	DAN breath-hold incident database records: 2004-2005	Modi
1445-1500	:15	Diving habits historically associated with 'shallow water blackout' in Hawaiian freedivers	Smerz
1500-1525	:25	Break / Informal Discussion	
1525-1615	:50	A proposed rule for breath-hold safety	Butler
1615-1655	:40	Shallow water blackout: the problem and a potential solution	Maas
Session C		Moderators: Lindholm/Pollock/Lundgren	
0800-0905	1:05	Safety techniques and problem management of recreational and competitive freediving	Krack, Cruickshank, Stepanek
0905-1005	1:00	Breath-hold diving on empty lungs, pulmonary edema and hemoptysis	Lindholm
1005-1030	:25	Break / Informal Discussion	
1030-1110	:40	Laryngospasm in breath-hold diving	Dueker
1110-1200	:50	Cardiovascular and hematological adjustments to apneic diving in humans	Schagatay
1200-1330		Lunch	
Session D		Moderators: Pollock/Wong	
1330-1345	:15	Correlation between spleen size and hematocrit during apnea in humans	Schagatay
1345-1435	:50	Decompression sickness in breath-hold diving	Wong
1435-1450	:15	Manifestation of DCI in Japanese Ama divers	Koshi
1450-1505	:15	Brain imaging in asymptomatic elite breath-hold divers	Potkin
1505-1530	:25	Break / Informal Discussion	
1530-1550	:20	Breath-hold diving and intravascular bubbles	Huggins
1550-1650	1:00	Panel discussion	Lundgren, Lindholm, Pollock, Butler, Dueker, Krack, Schagatay, Wong
1650-1700	:10	Closing remarks and adjournment	Lundgren